

SEGNO - idee Luce

Segno

The **Segno** brand is one characterised by elegance, style, functional research and aesthetics. High quality materials, the study of colours, maximum reliability, safety and high quality are granted by manufacturing entirely Made in Italy and they ensure that each Segno lamp is a high quality one that communicates with the surrounding area.

To illuminate a place means to transmit emotions in all of the modern living areas- homes, offices and commercial and public places.

We have collaborated with many prestigious architects, among which are Ezio Didone, Adrain Peach, Marco Merendi, De-Signum, Ferrara Palladino, Giancarlo Tintori, Simone Micheli, Silvio De Ponte, Roberto Paoli, Diego Ven-cato, Lucy Salamanca. The collection is provided with the most modern and efficient led sources so as to combine aesthetics with the maximum energy saving.



Capitolo | Chapter



TAVOLO
TABLE

26 - 49



SOSPENSIONI
SUSPENSION

50 - 83



COORDINATI
COORDINATED

84 - 127



PARETE PLAFONE PIANTANA INCASSO
CEILING WALL FLOOR RECESSED

128 - 213



E INOLTRE...
AND ALSO...

214 - 241

Indice | Indice



238

1410
Relcogroup engineering



239

2005
Relcogroup engineering



240

2007
Relcogroup engineering

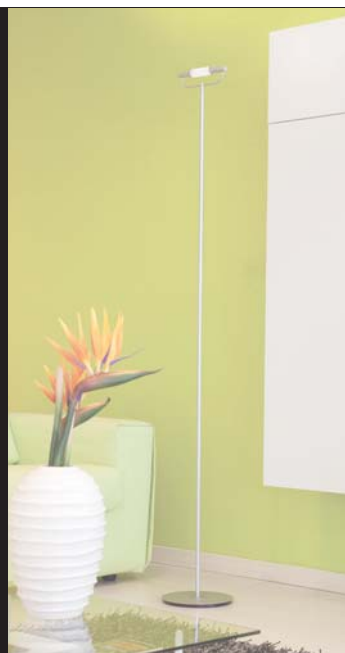

209

2008
Relcogroup engineering



211

2009
Relcogroup engineering



213

2010
Relcogroup engineering



241

2742D
Relcogroup engineering



137

BABY
Francesco Murano

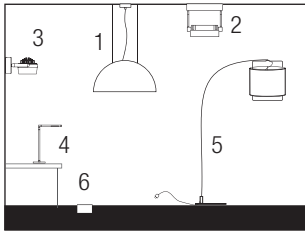

- 1. sospensione | suspension
- 2. plafone | ceiling
- 3. parete | wall
- 4. tavolo | table
- 5. terra | floor
- 6. incasso | recessed

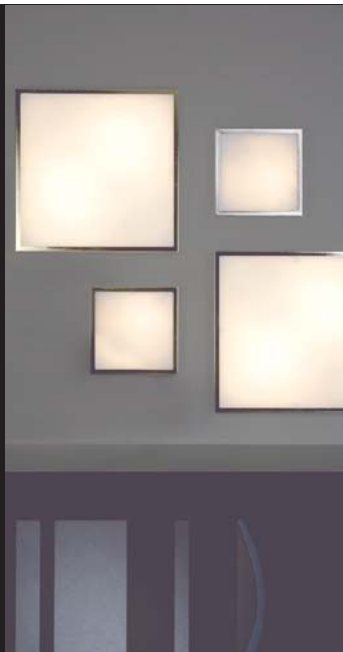

217

CAMELIA
Relcogroup engineering



223

EGO
Relcogroup engineering



37

FABH
Relcogroup engineering



161

GIACINTO
Relcogroup engineering



53

LED AURA
Giancarlo Tintori



234

LED AUSTRALIA
Relcogroup engineering



135

LED AXOLUTE W MINI
Relcogroup engineering

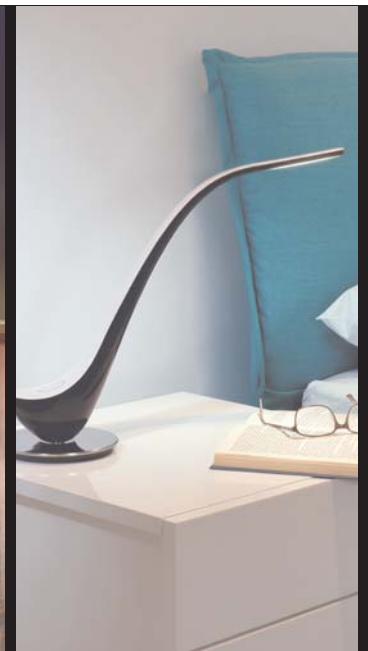

29

LED BETTY
Betty Wu

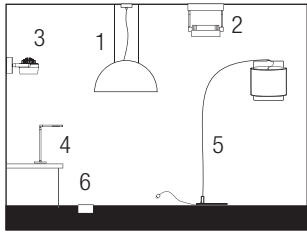

- 1. sospensione | suspension
- 2. plafone | ceiling
- 3. parete | wall
- 4. tavolo | table
- 5. terra | floor
- 6. incasso | recessed



229

KIDS SPOT
Relcogroup engineering



219

KUBIK
Relcogroup engineering



176

LED ARCO
Relcogroup engineering



131

ASTER - LED ASTER
Ezio Didone



139

LED BOX
Samanta Frison



226

LED BRERA
Relcogroup engineering



177

LED CONCA
Relcogroup engineering



88

LED CORALLO APPLIQUE
Relcogroup engineering

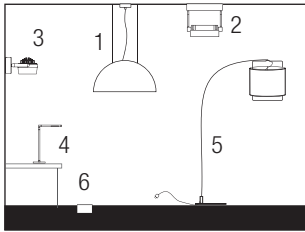

- 1. sospensione | suspension
- 2. plafone | ceiling
- 3. parete | wall
- 4. tavolo | table
- 5. terra | floor
- 6. incasso | recessed



89

LED CORALLO PIANTANA
Relcogroup engineering



90

LED CORALLO SOSPENSIONE
Relcogroup engineering



91

LED CORALLO TAVOLO
Relcogroup engineering



179

LED CUBE 1G
Relcogroup engineering



147

LED EGOO
Alan Foster



153

LED EQUAL BIG
Giancarlo Tintori



155

LED EQUAL MINI
Giancarlo Tintori



157

LED ETOILE
AGP

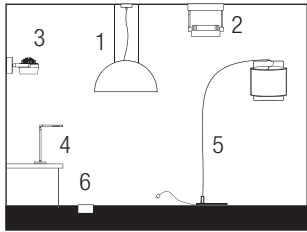

- 1. sospensione | suspension
- 2. plafone | ceiling
- 3. parete | wall
- 4. tavolo | table
- 5. terra | floor
- 6. incasso | recessed



181

LED CUBE 2P
Relcogroup engineering



143

LED DADO
Alan Foster



145

LED DADO MINI
Alan Foster



33

LED DISKO RGB
Relcogroup engineering



103

LED FLEXA F
Didier Raimbault



105

LED FLEXA FF
Didier Raimbault



99

LED FLEXA S
Didier Raimbault

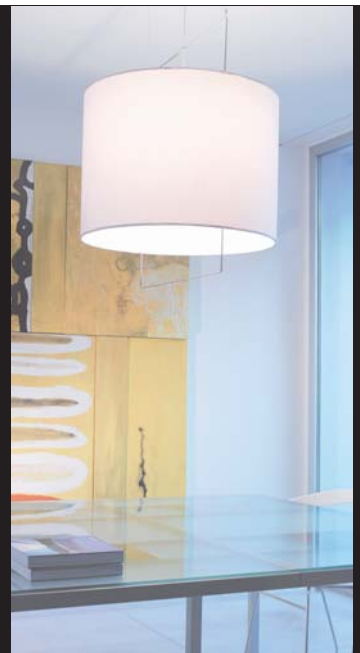

95

LED FLEXA S MAXI
Didier Raimbault

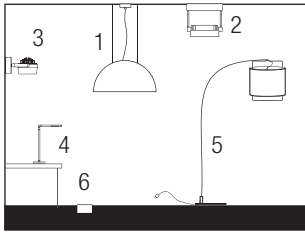

- 1. sospensione | suspension
- 2. plafone | ceiling
- 3. parete | wall
- 4. tavolo | table
- 5. terra | floor
- 6. incasso | recessed



97

LED FLEXA S MINI
Didier Raimbault



109

LED FLEXA TAVOLO
Didier Raimbault

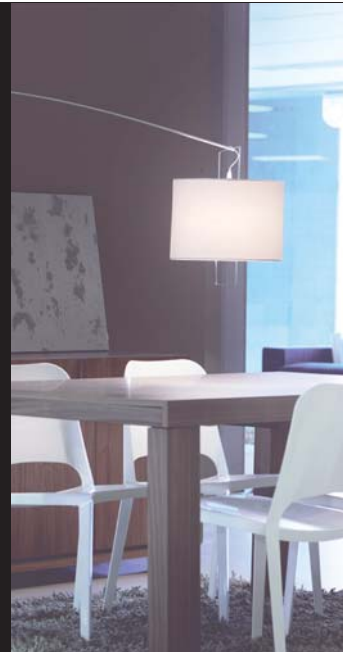

101

LED FLEXA W
Didier Raimbault



61

LED FORMA
Diego Vencato



173

LED L'ARCOBALENO RGB
Gianni Bellato



39

LED LED
Roberto Lucci & Paolo Orlandini



185

LED LEON
Relcogroup engineering



183

LED LINE
Relcogroup engineering

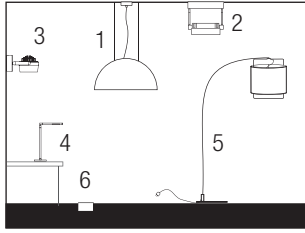

- 1. sospensione | suspension
- 2. plafone | ceiling
- 3. parete | wall
- 4. tavolo | table
- 5. terra | floor
- 6. incasso | recessed



165

LED GLASS
Andrea Castelli & Fabio Rezzonico



169

LED GOLF
Ferrara Palladino



171

LED GOLF RC
Ferrara Palladino



237

LED GRAZ
Relco Group engineering



235

LED MELBOURNE
Relcogroup engineering



41

LED META
Ezio Didone



224

LED MONACO
Relcogroup engineering



45

LED MOOD
Marco Merendi

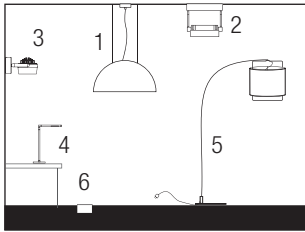

- 1. sospensione | suspension
- 2. plafone | ceiling
- 3. parete | wall
- 4. tavolo | table
- 5. terra | floor
- 6. incasso | recessed



236

LED NASKA
Relcogroup engineering



113

LED NOTA C-W
Adrian Peach



115

LED NOTA F
Adrian Peach



49

LED O'RING
Marco Merendi



189

LED QUADRO
Relcogroup engineering



65

LED QUEEN'S
Silvio De Ponte & Pietro Gaeta

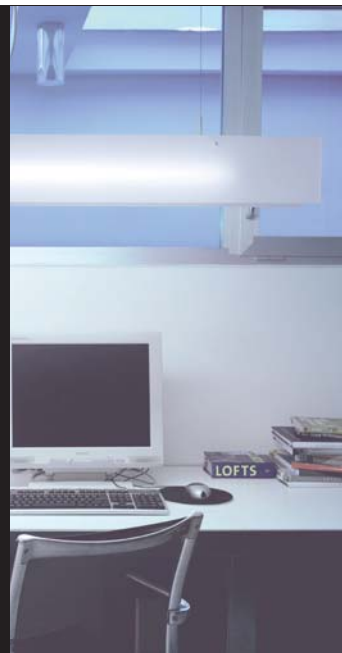

67

LED QUINTA
Adrian Peach



195

LED ROCK
Andrea Castelli & Fabio Rezzonico

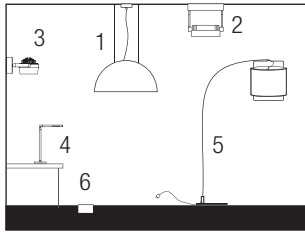

- 1. sospensione | suspension
- 2. plafone | ceiling
- 3. parete | wall
- 4. tavolo | table
- 5. terra | floor
- 6. incasso | recessed



189

LED OVALE
Relcogroup engineering



232

LED PERTH
Relcogroup engineering



83

LED PLEX
Relcogroup engineering



191

POINT HALO - LED POINT
Alan Foster



187

LED SCUDO
Relcogroup engineering



73

LED SFERA
Relcogroup engineering



231

LED SPOT
Relcogroup engineering



75

LED STILNOVO
Relco Group engineering

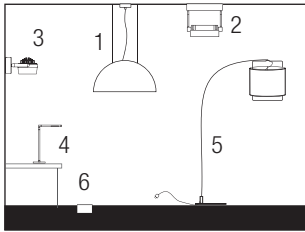

- 1. sospensione | suspension
- 2. plafone | ceiling
- 3. parete | wall
- 4. tavolo | table
- 5. terra | floor
- 6. incasso | recessed



233

LED SYDNEY
Relco Group engineering



199

LED TABLOID
Adrian Peach



201

LED TA-TA
Diego Vencato



205

LED THEO
Leonardo Laiti



226

LED ZEDRA
Relco Group engineering



77

LED ZENO
Relcogroup engineering



81

LINE S
Relcogroup engineering

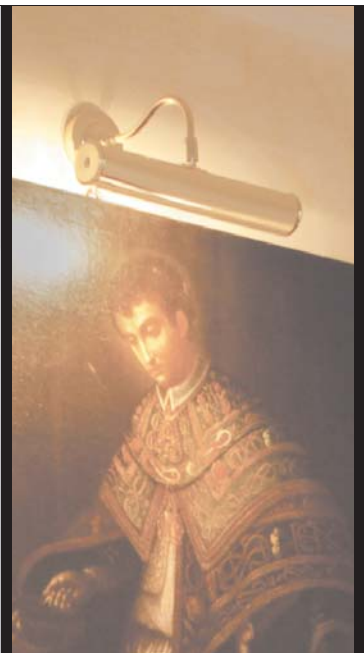

225

MORRISON
Relcogroup engineering

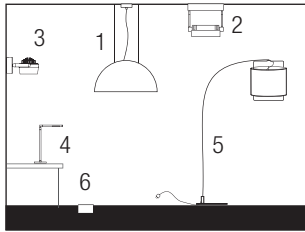

- 1. sospensione | suspension
- 2. plafone | ceiling
- 3. parete | wall
- 4. tavolo | table
- 5. terra | floor
- 6. incasso | recessed



119

LED TRIBECA C
Andrea Castelli & Fabio Rezzonico



121

LED TRIBECA S
Andrea Castelli & Fabio Rezzonico



125

LED TRIBECA S CUBE
Andrea Castelli & Fabio Rezzonico



127

LED TRIBECA W
Andrea Castelli & Fabio Rezzonico



63

OFEK
Yaacov Kaufman



207

OLIVIA
Spalvieri / Del Ciotto



221

PRIMULA
Relcogroup engineering













197

STICK
Andrea Castelli & Fabio Rezzonico

Listino figurato | *Illustrated list*

Le lampade Segno hanno come caratteristica propria quella di essere duttili e versatili. Si prestano cioè a diversi utilizzi come sintetizzato nell'elenco figurato delle pagine seguenti: un'utile guida per installatori ed utenti che sintetizza, per ogni prodotto, il posizionamento ideale, il grado IP, l'adattabilità alle intemperie e la sorgente luminosa.













The distinguishing features of Segno lamps are ductility and versatility. Meaning that they can be employed for the various uses outlined in the list on the following pages: a useful guide for installation technicians and users providing a brief description for each product of the ideal position, the IP rating, its adaptability to the elements and its light source.

Articolo Article	pag.	IP		INTERIOR	OUTDOOR	CEILING	FLOOR	RECESSED	SIGNAL	SUSPENSION	TABLE	WALL
	1410	238	20	E27-E14	●	-	-	●	-	-	-	-
	2005	239	20	R7s	●	-	-	●	-	-	-	-
	2007	240	20	GU10	●	-	-	●	-	-	-	-
	2008	209	20	R7s	●	-	-	●	-	-	-	-
	2009	211	20	R7s	●	-	-	●	-	-	-	-
	2010	213	20	R7s + LED	●	-	-	●	-	-	-	-
	2742D	241	20	E27	●	-	-	●	-	-	-	-
	Baby	137	20	E27	●	-	-	-	-	-	●	-
	Camelia	217	20	E27	●	-	-	-	-	-	-	●
	Ego	223	20	E27	●	-	●	-	-	-	-	●



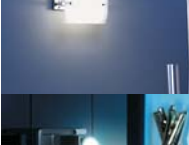

Listino figurato - Illustrated list

	Articolo Article	pag.	IP		INTERIOR	OUTDOOR	CEILING	FLOOR	RECESSED	SIGNAL	SUSPENSION	TABLE	WALL
	Fabh	37	20	Halo G9	●	-	-	-	-	-	-	●	-
	Giacinto	161	20	R7s	●	-	-	-	-	-	-	-	●
	Kids Spot	229	20	E14	●	-	●	-	-	-	-	-	-
	Kubik	219	20	E14	●	-	●	-	-	-	-	●	●
	Led Arco	176	20	E27	●	-	●	-	-	-	-	-	●
	Aster Led Aster	131	65	2GX13 LED	-	●	●	-	-	-	-	-	●
	Led Aura 3	53	20	LED	●	-	-	-	-	●	●	-	-
	Led Australia	234	20	LED	●	-	-	-	-	-	-	●	-
	Led Axolute W Mini	135	20	LED	●	-	-	-	-	-	-	-	●
	Led Betty	29	20	LED	●	-	-	-	-	-	-	●	-
	Led Box	139	40	LED	●	-	-	-	-	-	-	-	●
	Led Brera	226	20	LED	●	-	-	-	-	●	-	-	●
	Led Conca	177	20	E27	●	-	●	-	-	-	-	-	●















Listino figurato - Illustrated list

	Articolo Article	pag.	IP		INTERIOR	OUTDOOR	CEILING	FLOOR	RECESSED	SIGNAL	SUSPENSION	TABLE	WALL
	Led Corallo	87	20	E27	●	-	-	●	-	-	●	●	●
	Led Cube 1G	179	20	LED	●	-	-	-	-	-	-	-	●
	Led Cube 2P	181	20	LED	●	-	-	-	-	-	-	-	●
	Led Dado	143	20	E27 GU10	●	-	●	-	-	●	-	-	●
	Led Disko	33	41	LED	●	-	-	-	-	-	-	●	-
	Led Ego	147	44	E27	-	●	●	●	-	-	-	-	●
	Led Equal	151	20	LED	●	-	●	-	-	-	-	-	●
	Led Etoile	157	20	LED	●	-	●	-	-	-	-	-	●
	Led Flexa	93	20	E27	●	-	-	●	-	-	●	●	●
	Led Forma	61	20	LED	●	-	-	-	-	-	●	-	-
	Led Glass	165	20	R7S	●	-	●	-	-	-	-	-	●
	Led Golf	169	20	LED	●	-	●	-	●	-	-	-	●
	Led Graz	237	20	LED	●	-	-	-	-	-	-	●	-











Listino figurato - Illustrated list

	Articolo Article	pag.	IP		INTERIOR	OUTDOOR	CEILING	FLOOR	RECESSED	SIGNAL	SUSPENSION	TABLE	WALL
	Led L'Arcobaleno RGB	173	20	LED	●	-	●	●	-	-	-	-	●
	Led Led	39	20	LED	●	-	-	-	-	-	-	●	-
	Led Leon	185	20	E27	●	-	-	-	-	-	-	-	●
	Led Line	183	20	LED	●	-	-	-	-	-	-	-	●
	Led Melbourne	235	20	LED	●	-	-	-	-	-	-	●	-
	Led Meta	41	20	E27	●	-	-	-	-	-	-	●	-
	Led Monaco	224	20	LED	●	-	-	-	-	-	-	-	●
	Led Mood	45	20	LED	●	-	-	-	-	-	-	●	-
	Led Naska	236	20	LED	●	-	-	-	-	-	-	●	-
	Led Nota	111	20	E27	●	-	●	●	-	-	-	-	●
	Led O'ring	49	20	LED	●	-	-	-	-	-	-	●	●
	Led Ovale	189	20	LED	●	-	-	-	-	-	-	-	●
	Led Perth	232	20	LED	●	-	-	-	-	-	-	●	-

Listino figurato - Illustrated list

	Articolo Article	pag.	IP		INTERIOR	OUTDOOR	CEILING	FLOOR	RECESSED	SIGNAL	SUSPENSION	TABLE	WALL
	Led Plex	83	20	E27	●	-	-	-	-	-	●	-	-
	Point Halo Led Point	191	40	LED	●	-	●	-	-	-	-	-	●
	Led Quadro	189	20	LED	●	-	-	-	-	-	-	-	●
	Led Queen's	65	20	G9 + E27	●	-	-	-	-	-	●	-	-
	Led Quinta	67	20	LED	●	-	●	-	-	-	●	-	●
	Led Rock	195	20	R7s	●	-	●	-	-	-	-	-	●
	Led Scudo	187	20	E27	●	-	-	-	-	-	-	-	●
	Led Sfera	73	20	LED	●	-	-	-	-	-	●	-	-
	Led Spot	231	20	LED	●	-	●	-	-	-	-	-	-
	Led Stilnovo	75	20	E27	●	-	-	-	-	-	●	-	-
	Led Sydney	233	20	LED	●	-	-	-	-	-	-	●	-
	Led Tabloid	199	20	E27	●	-	-	-	-	-	-	-	●
	Led Ta-ta	201	20	R7s	●	-	-	-	●	-	-	-	●

Listino figurato - Illustrated list





	Articolo Article	pag.	IP		INTERIOR	OUTDOOR	CEILING	FLOOR	RECESSED	SIGNAL	SUSPENSION	TABLE	WALL
	Led Theo	205	20	LED G4	●	-	●	-	-	-	-	-	-
	Led Tribeca	117	20	E14-E27	●	-	●	-	-	-	●	-	●
	Led Zedra	226	20	LED	●	-	-	-	-	-	-	-	●
	Led Zeno	77	20	LED	●	-	-	-	-	-	●	-	-
	Line S	81	20	G5 T5	●	-	●	-	-	-	-	-	-
	Morrison	225	20	E14	●	-	-	-	-	-	-	-	●
	Ofek	63	20	G5 T5	●	-	-	-	-	-	●	-	-
	Olivia	207	20	G5 T5	●	-	-	●	-	-	-	-	-
	Primula	221	20	R7x	●	-	-	-	-	-	-	-	●
	Stick	197	20	R7s	●	-	●	-	-	-	-	-	●

Legenda | Legend

Materiali Body

	Bianco (WH) <i>White (WH)</i>
	Bianco (WH) <i>White (WH)</i>
	Nero (BK) <i>Black (BK)</i>
	Grigio (GR) <i>Grey (GR)</i>
	Alluminio (AA) <i>Aluminium (AA)</i>
	Alluminio lucido (AB) <i>Brilliant aluminium (AB)</i>
	Alluminio ossidato (AO) <i>Oxidized aluminium (AO)</i>
	Argento (AG) <i>Silver (AG)</i>
	Oro (GD) <i>Gold (GD)</i>
	Cromo (CR) <i>Chrome (CR)</i>
	Nichel (NK) <i>Nickel (NK)</i>
	Rosso (RD) <i>Red (RD)</i>
	Blu (BL) <i>Blue (BL)</i>
	Naturale (NT) <i>Natural (NT)</i>

Colori tessuti Fabric colours

	Bianco (WH) <i>White (WH)</i>
	Écru (NT) <i>Écru (NT)</i>
	Nero (BK) <i>Black (BK)</i>
	Bianco Melange (WH/MP) <i>White Melange (WH/MP)</i>
	Nero Melange (BK/MP) <i>Black Melange (BK/MP)</i>
	Rosso (RD) <i>Red (RD)</i>

Temperatura di colore LED Colour LED temperature

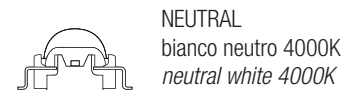
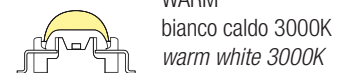
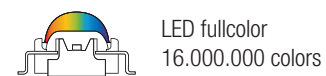

Simboli | Symbols

Legenda simboli Legend symbols

S = Corpo apparecchio
Lighting fitting

S+L = Corpo apparecchio + lampada
Lighting fitting + lamp

L = Lampadina
Lamp

CELL = Corpo apparecchio + alimentazione elettronica + lampada
Lighting fitting + electronic gear + lamp

Euro I prezzi indicati sono da considerarsi IVA esclusa



Apparecchio che può essere installato su superfici normalmente infiammabili.
Devices that can be installed on flammable surfaces.



Tutti i prodotti sono in conformità alle norme EN60598-1.
All products comply with EN60598-1 standards.



Apparecchio di classe I
Class I



Apparecchio di classe II
Class II



Apparecchio di classe III
Class III



Dimensioni foro incasso
Hole for fitting dimensions



Grado di protezione IP
IP protection degree



Accessori ed installazione
Accessoires and instructions



Su tutte le lampade Segno le sorgenti luminose a LED sono sempre comprese, eco compatibili e di ultima generazione.

Le sorgenti luminose a LED non possono essere usate con i vecchi light dimmer elettronici. Se necessario, consultare il sito www.relco.it capitolo "variatori di intensità luminosa", sezione "Variatori per sorgenti luminose a led - DIMLED" oppure contattare il proprio installatore di fiducia.

The LED lamps are always included on all Segno fittings, ecological last generation.

The LED light sources cannot be used with old electronic light dimmer. If necessary, please visit www.relco.it chapter "light dimmer", section "Variable for source LED - DIMLED" or contact your installer.





TAVOLO



TABLE

da
from

26

a
to

49





Led Betty è la nuova lampada da tavolo dal design innovativo e accattivante, ultima nata in casa "Segno", marchio del Gruppo Relco. Betty è più di una lampada, è un oggetto d'arredo dall'alto contenuto estetico che unisce all'armonia delle forme, un'elevata funzionalità grazie ad un sensore touch dimmer che ne determina l'accensione e lo spegnimento. Il sensore è circondato da un segnalatore luminoso che ne permette l'individuazione al buio mentre il prolungato contatto con la parte sensoriale regola l'intensità luminosa che Led Betty memorizza e ripristina all'accensione successiva. L'utilizzo di sorgente Led garantisce un notevole risparmio energetico e lunga durata oltre ad emettere una "luce pulita" perché priva di emissioni elettromagnetiche nocive, infrarosse ed ultraviolette, gas pericolosi, sostanze inquinanti e tossiche nocive sia per l'uomo e per l'ambiente. Led Betty è l'ideale per accompagnare le ore di studio, di lavoro e i momenti di relax. Disponibile in tre varianti colore: nero, grigio e bianco.

Caratteristiche tecniche:

Corpo in tecnopolimero (simile alla fibra di carbonio), diffusore in policarbonato, base in alluminio cromato.

Alimentatore elettronico Relco incorporato.

Lampada LED a corredo.

Betty Led, the latest addition to the "Segno" family, a Relco Group brand, is the new table lamp with an innovative and captivating design. Betty is more than a lamp, it is an object that enhances the décor with its high aesthetic content, which combines the harmony of its shapes with excellent function, thanks to a touch dimmer sensor to switch it on and off. The sensor is surrounded by a luminous signal making it visible in the dark, while prolonged contact with the sensitive part will adjust the light intensity, which Betty Led memorises and uses again the next time the lamp is switched back on. Using a Led source guarantees considerable energy savings and extended service-life in addition to providing a "clean light", meaning that it does not contain any harmful electromagnetic, infra-red or ultraviolet emissions, hazardous gases, polluting and toxic substances that are harmful to man and the environment. Betty Led is the ideal light for studying, working and also for relaxing. It is available in three different colours: black, grey and white.

Technical features:

Technopolymer body (similar to carbon fibre), polycarbonate shade, chrome-plated base.

Built-in Relco electronic power supply unit.

LED lamp included.



Touch Dimmer

Sensore per l'accensione/spegnimento e regolazione dell'intensità luminosa della lampada.

Touch Dimmer

On/off and dimming sensor.

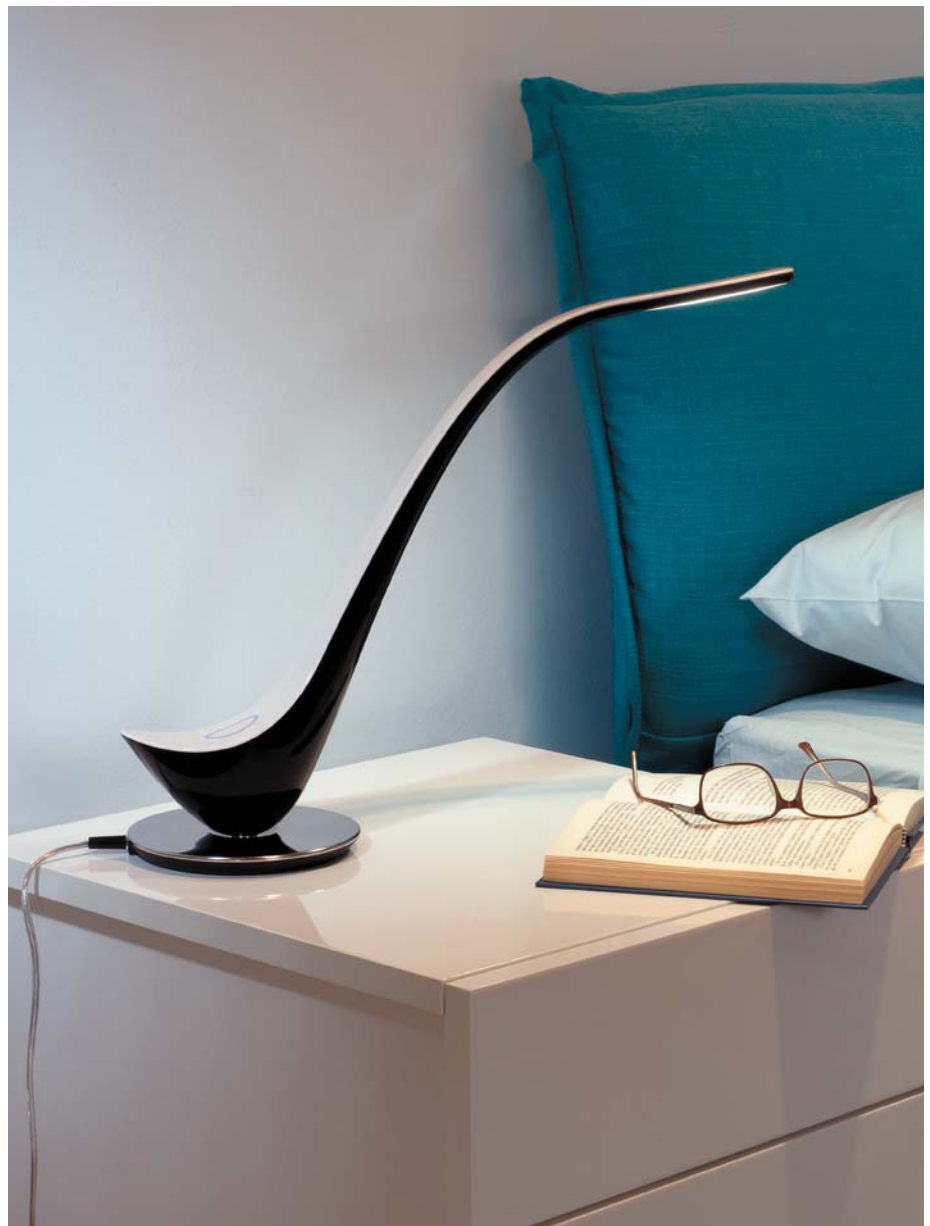



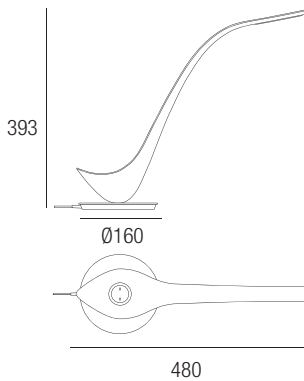

LED BETTY

Codice	Code	Euro
27299	CELL	218,40

Materiali *Body*



Nero (BK)
Black (BK)

Peso/Weight
1,81 Kg

Fonti luminose/Light source



> 30.000 h.

6W LED 220÷240V 350mA 3000K

LED BETTY

Codice	Code	Euro
27298	CELL	218,40

Materiali *Body*



Bianco (WH)
White (WH)

Peso Weight
1,81 Kg

Fonti luminose *Light source*



> 30.000 h.

6W LED 220÷240V 350mA 3000K

LED BETTY

Codice	Code	Euro
27300	CELL	218,40

Materiali *Body*



Alluminio (AA)
Aluminium (AA)

Peso Weight
1,81 Kg

Fonti luminose *Light source*



> 30.000 h.

6W LED 220÷240V 350mA 3000K

LED **6W** = **35W HALO**



LED **6W** = **35W HALO**



LED **6W** = **35W HALO**





WYBOROWA

Since 1823

WÓDKA
WYBOROWA

PURE RYE GRAIN
VODKA

IMPORTED
FROM POLAND

40% vol 700 ml e



Led Disko RGB è un simpatico apparecchio luminoso adatto per personalizzare e dare valore a tutti gli ambienti. Tondo, leggero e poco ingombrante, ricorda la forma di un disco volante ed è dotato di LED di potenza che cambiano colore (RGB Fullcolor con durata superiore a 30.000 ore). Ideale per decorare una tavola imbandita o il bancone di un bar, può essere posizionato sotto bottiglie, bicchieri, oggetti oppure può essere esso stesso complemento d'arredo innovativo e luce da compagnia. Ottimo anche come regalo originale e di sicuro successo. Con LED Disko scegli l'atmosfera che più ti piace e con un semplice pulsante cambi il colore della tua luce.

Disponibile in tre versioni: LED Disko 3W, LED Disko Plus 9W o LED Disko Mobile 3W con batterie ricaricabili (autonomia circa 3h) che ne permettono lo spostamento anche lontano dalla presa di corrente.

Caratteristiche tecniche:

Corpo in materiale termoplastico verniciato in argento.

Alimentatore elettronico (Relco) a spina.

The Disko RGB Led is a fun light fixture suitable to personalise and enhance the value of any setting. Round, light and compact, its shape resembles a UFO and is fitted with power LEDs that change colour (Fullcolor RGB with a lifespan of more than 30,000 hours). Ideal for decorating a fully set table, or a counter in a bar, it can be installed under bottles, glasses and objects, or it can be an innovative piece of furnishing on its own to create atmosphere. It also makes an excellent, original gift that will definitely be a success. With Disko LED you can choose the atmosphere you prefer, and change the colour of the light by simply pressing a button.

Available in three versions: 3W Disko LED, 9 W Disko Plus LED or 3W Disko Mobile LED with rechargeable batteries (approximately 3 hours of autonomy) so that it can also be placed far away from the power outlet.

Technical features:

Thermoplastic, silver painted body.

Plug-in electronic power supply unit (Relco).





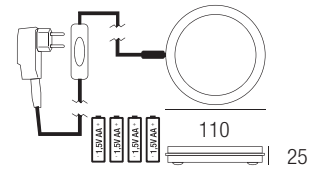
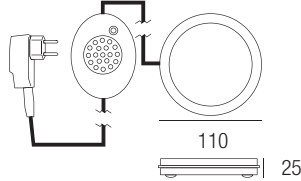
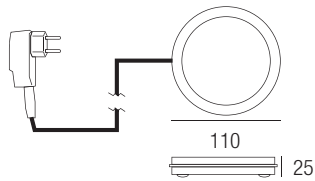

LED DISKO

Codice *Code* Euro
30835 **CELL** **73,71**

Materiali *Body*



Alluminio (AA)
 Aluminium (AA)

Peso *Weight*
0,11 Kg

Fonti luminose *Light source*



> 30.000 h.

3W LED RGB FULLCOLOR 230V - 50Hz

LED DISKO PLUS

Codice *Code* Euro
30836 **CELL** **154,25**

Materiali *Body*



Alluminio (AA)
 Aluminium (AA)

Peso *Weight*
0,11 Kg

Fonti luminose *Light source*



> 30.000 h.

3x3W LED RGB FULLCOLOR 230V - 50Hz

LED DISKO MOBILE BATTERY

Codice *Code* Euro
30837 **CELL** **98,28**

Materiali *Body*



Alluminio (AA)
 Aluminium (AA)

Peso *Weight*
0,20 Kg

Fonti luminose *Light source*



> 30.000 h.

3W LED RGB FULLCOLOR 230V - 50Hz



LED **3W** =  **20W HALO**



LED **3W** =  **20W HALO**



LED **3W** =  **20W HALO**







Fahb è una lampada d'ultima generazione, multifunzionale, di concezione olistica, unica perchè coinvolge i cinque sensi, olfatto compreso. Un oggetto prezioso e originale, frutto di una creatività che si spinge oltre, che ricerca soluzioni di arredo capaci di connotare lo spazio migliorandone la qualità e la percezione. Fahb illumina e profuma, crea atmosfera e la riempie con profumazioni personalizzabili. Realizzata con tecniche artigianali, è una lampada da appoggio che può essere ubicata ovunque, in ufficio, nelle abitazioni, nelle camere da letto così come nei salotti o negli studi. Esteticamente molto gradevole, ha una forma cilindrica adatta per contenere bastoncini in legno naturale che fungono da diffusori di essenze. Sopra la sorgente, infatti, si trova un piccolo raccoglitore in alluminio dove è possibile inserire qualche goccia di soluzione profumata non alcoolica. La sorgente emette una luce calda ed avvolgente modulabile attraverso dimmer: l'intensità luminosa regola anche la quantità di essenza liberata nell'ambiente.

Caratteristiche tecniche:

Base in legno

Diffusore in vetro sabbato

Bastoncini in legno di balsa pre-impregnati di essenza profumata.

Cablaggio fornito con dimmer (RELCO) sul cavo di alimentazione.

Nota: lievi imperfezioni superficiali o cambi di spessore sono caratteristiche tipiche di lavorazioni artigianali e vetri di qualità. Esse non sono pertanto da considerarsi come difetti di fabbricazione ma pregi di lavorazioni fatte a mano.

Fahb is a last-generation, multifunctional lamp, based on a holistic, unique concept that engages all five senses, including smell. It is a valuable and original object, the result of creativity that takes it to the next level, that aims to offer furnishing solutions that enhance the setting, improving the quality and perception of it. Fahb provides light, scent, creates atmosphere and fills it with customisable fragrances. It is built using the techniques of craftsmanship. It is a free-standing lamp that can be set up anywhere, in the office, in the house, in the bedroom, as well as in the living room or in the study. It is very aesthetically appealing. Its cylindrical shape is suitable to contain natural wooden sticks that act as essence diffusers. In fact, there is a small aluminium bowl above the source, where you can put in a few drops of non-alcoholic scented solution. The source emits a warm and enveloping light that can be adjusted from the dimmer: the light intensity also regulates the amount of scent that is dispersed into the room.

Technical features:

Wooden base

Sanded glass shade

Pre-soaked scented balsa wood sticks.

Wiring included with dimmer (RELCO), on the power supply cable.

Note: slight imperfections on the surface or differences in thickness are typical signs of craftsmanship and quality glass. Accordingly, these are not considered factory defects, rather the distinguishing marks of hand-processing.

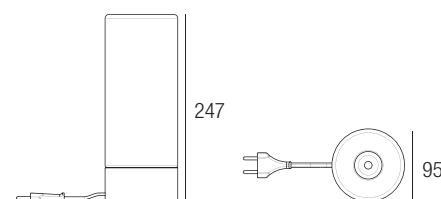

FAHB

Codice	Code	Euro
310100	CELL	338,52

Materiali *Body*



Bianco (WH)
White (WH)

Peso *Weight*

1,00 Kg

Fonti luminose *Light source*



> 30.000 h.

33W G9 Halo 220÷240V 50Hz - 3000K

HALO **33W** =  **40W** Classic







Led Led è una simpatica lampada da tavolo, snodabile, flessibile, insolita perché si può vedere come è fatta dentro, come funziona, come si accende: la base infatti è in ABS trasparente. Unica nel suo genere! E' una lampada da tavolo che può essere posizionata anche a parete. Un pezzo storico della collezione Segno, insignita più volte di riconoscimenti proprio per le sue valenze di design. E' adatta come luce da lettura o relax, poco ingombrante e leggera.

Caratteristiche tecniche:

Trasformatore elettronico (Relco).
Cavi flessibili in rame argentato rivestiti in PVC trasparente.
Riflettore in alluminio anodizzato.

Led Led is a cute table lamp, articulated, flexible, unusual because you can see how it is made inside, how it works, how it switches on: in fact, the base is made of transparent ABS. One of a kind! It is a table-lamp that can also be wall-mounted. It is a historical piece of the Segno collection, the recipient of several recognitions for its appreciated design. It provides suitable light for reading or relaxing, quite compact and lightweight.

Technical features:

Electronic transformer (Relco).
Flexible silver-plated copper cables, coated with transparent PVC.
Anodised aluminium reflector.

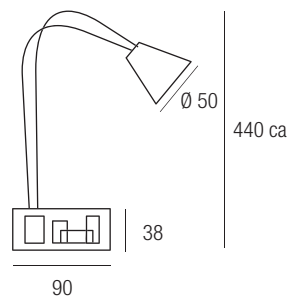

LED LED

Codice Code Euro
020100 CELL 126,95

Materiali Body



Naturale (NT)
Natural (NT)

Peso Weight

0,7 Kg

Fonti luminose Light source



> 30.000 h.

4W POWERLED 220÷240V 4000K lens 110°

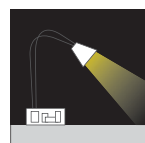

LED **4W** = **20W HALO**





LED META è un'elegante lampada da tavolo, dalle linee minimali ben si sposa con qualsiasi stile abitativo. E' una lampada moderna che coniuga tradizione e tecnologia, diffonde una luce calda, avvolgente e gradevole, regolabile in intensità. Ha il corpo in metallo verniciato lucido ed è disponibile nei colori bianco o nero. Il diffusore può essere anch'esso in metallo verniciato lucido oppure in tessuto accoppiato con PVC nei colori bianco tramato o nero tramato.

Caratteristiche tecniche:

Dimmer Relco incluso
Lampada LED inclusa

META LED is an elegant table lamp, with minimal lines, that goes well with any style of home-furnishing. It is a modern lamp that combines tradition with technology, providing a warm, enveloping, pleasant, intensity-adjustable light. It has a glossy painted metal body, and is available in white or black. The shade is also glossy painted metal or fabric combined with PVC, in a white pattern or a black pattern.

Technical features:

Relco dimmer included
LED lamp included

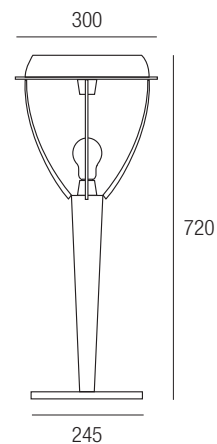
LED META

Codice *Code* Euro
250001 S+L 414,83

Materiali *Body*



Nero (BK)
Black (BK)

Peso *Weight*

1,81 Kg

Fonti luminose *Light source*



> 30.000 h.

8W LED E27 220÷240 3000K lens 300°

LED META

Codice *Code* Euro
250002 S+L 422,70

Materiali *Body*



Bianco (WH)
White (WH)

Peso *Weight*

1,81 Kg

Fonti luminose *Light source*



> 30.000 h.

8W LED E27 220÷240 3000K lens 300°

LED **8W** =  **60W** classic



LED **8W** =  **60W** classic



Regolazione dell'intensità luminosa
Light intensity adjustment



LED META ABAT-JOUR

Codice *Code* Euro
250501 S 149,47

Per codice *For code*
250001 - 250002

Materiali *Body*
Metallo - Metal



Nero (BK)
Black (BK)

Peso *Weight*
0,40 Kg



LED META ABAT-JOUR

Codice *Code* Euro
250502 S 149,47

Per codice *For code*
250001 - 250002

Materiali *Body*
Metallo - Metal



Bianco (WH)
White (WH)

Peso *Weight*
0,40 Kg





LED META ABAT-JOUR

Codice *Code* Euro
250601 S 131,86

Per codice *For code*
250001 - 250002

Materiali *Body*
Tessuto - Fabric



Nero (BK)
Black (BK)

Peso *Weight*
0,15 Kg



LED META ABAT-JOUR

Codice *Code* Euro
250602 S 131,86

Per codice *For code*
250001 - 250002

Materiali *Body*
Tessuto - Fabric



Bianco (WH)
White (WH)

Peso *Weight*
0,15 Kg







LED MOOD è una lampada da appoggio per interni, disponibile nella versione a LED con luce bianca in tonalità fredda o nella versione a LED RGB per cambiare colore ad ogni ambiente. La forma di cubo con due lati aperti consente di orientare la luce ruotando la lampada, il diffusore è un cilindro in vetro Pirex satinato che emette una luce fredda e diffusa.

Caratteristiche tecniche:

Corpo in metallo verniciato in bianco.

Disponibile come accessorio, una mensola a muro per appoggiare la lampada.

Dimmer Relco incluso.

MOOD LED is a free-standing lamp for interiors, available in a LED version with a cool-white light or in an RGB LED version to change the colour of every room. Its cube shape with two open sides makes it possible for you to direct the ray light by turning the lamp. The shade is a satin-finish Pyrex glass cylinder that emits cool and diffused light.

Technical features:

White painted metal body.

A wall-mounted shelf is available, as an accessory to set the lamp on.

Relco dimmer included.

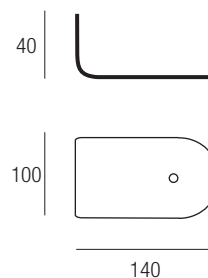

ACCESSORIO ACCESSORY

**MENSOLA per fissaggio a parete
SHELF for wall installation**

Codice Code Euro
735002 25,94

Materiali Body



Bianco (WH)
White (WH)

Peso Weight
0,3 Kg





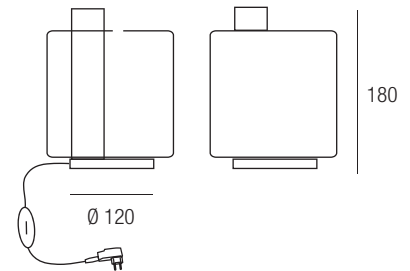
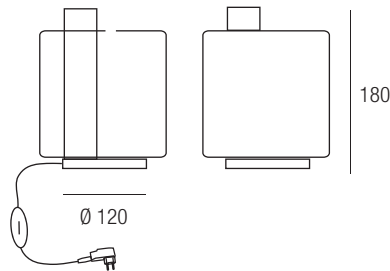
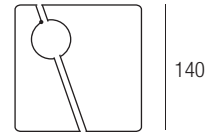
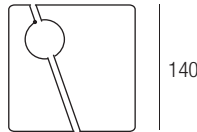

LED MOOD RGB

Codice *Code* Euro
730102 **CELL** **274,32**

Materiali *Body*



Bianco (WH)
White (WH)

Peso *Weight*
3,2 Kg

Fonti luminose *Light source*



> 30.000 h.

1x4W LED RGB FULLCOLOR



LED **4W** = **40W** classic



LED MOOD

Codice *Code* Euro
730302 **CELL** **229,32**

Materiali *Body*



Bianco (WH)
White (WH)

Peso *Weight*
3,2 Kg

Fonti luminose *Light source*



> 30.000 h.

3W POWERLED 700mA 6000K

LED **3W** = **30W** classic



Regolazione
dell'intensità luminosa
*Light intensity
adjustment*







Tavolo | Table



Parete | Wall

LED O'RING

Marco Merendi

LED O'RING è una lampada da interni da appoggio o da parete orientabili, duttili, poco ingombranti e molto pratiche. Infatti, il corpo costituito da una cornice in metallo verniciato bianco, nero o rosso, permette di orientare il diffusore centrale orientando così a proprio piacere il flusso luminoso. Perfetta per l'angolo studio e per la lettura, ideale per illuminare le tastiere di computer e piani di lavoro, è adatta a qualsiasi stile e arredo.

Caratteristiche tecniche:

Corpo in metallo verniciato.
Led di potenza 7W

O'RING LED is a free-standing or wall-mounted lamp for interiors. It is direction-adjustable, ductile, compact and very practical. In fact, its body is built with a white, black or red painted metal frame, which makes it possible to adjust the position of the central shade, and adjust the ray of light according to preference. It is perfect for a corner study and reading. It is the ideal lighting solution for computer keyboards and work surfaces, and it goes well with any style and décor.

Technical features:

Painted metal body.
7 W power led

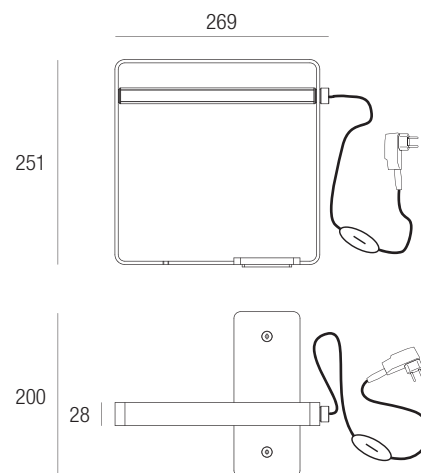
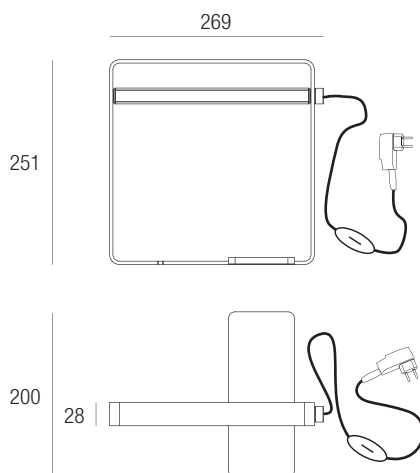

A richiesta - On request

LED O'RING T

Codice Code Euro
860003 CELL 273,00

Materiali Body



Rosso (RD)
Red (RD)

Fonti luminose Light source

> 30.000 h.
7W POWERLED 350mA 6000K lens 30°

LED O'RING T

Codice Code Euro
860002 CELL (WH) 270,27
860001 CELL (BK) 270,27

Materiali Body



860002
Bianco (WH)
White (WH)



860001
Nero (BK)
Black (BK)

Peso Weight
1,5 Kg

Fonti luminose Light source

> 30.000 h.
7W POWERLED 350mA 6000K lens 30°

LED O'RING W

Codice Code Euro
860102 CELL (WH) 253,89
860101 CELL (BK) 253,89

Materiali Body



860102
Bianco (WH)
White (WH)



860101
Nero (BK)
Black (BK)

Peso Weight
1,5 Kg

Fonti luminose Light source

> 30.000 h.
7W POWERLED 350mA 6000K lens 30°

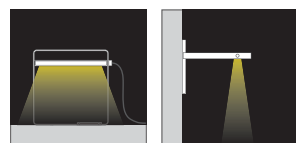

LED **7W** = **25W HALO**



LED **7W** = **25W HALO**



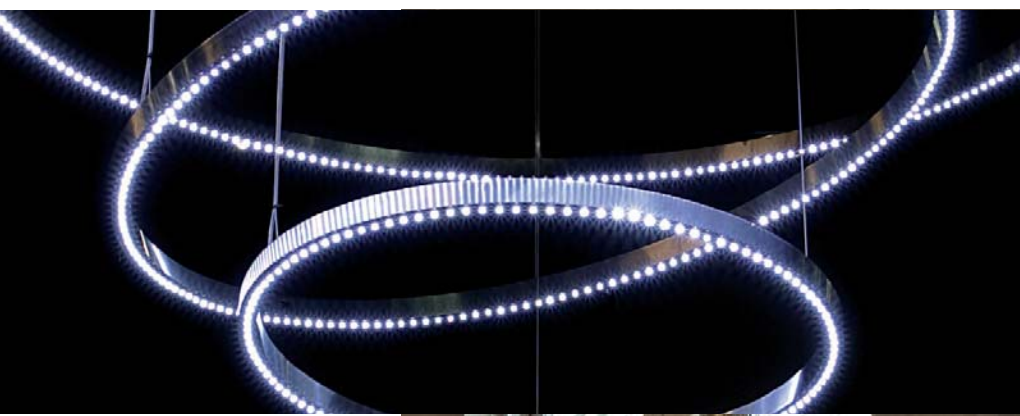



SOSPENSIONE



SUSPENSION

da
from

50

a
to

83

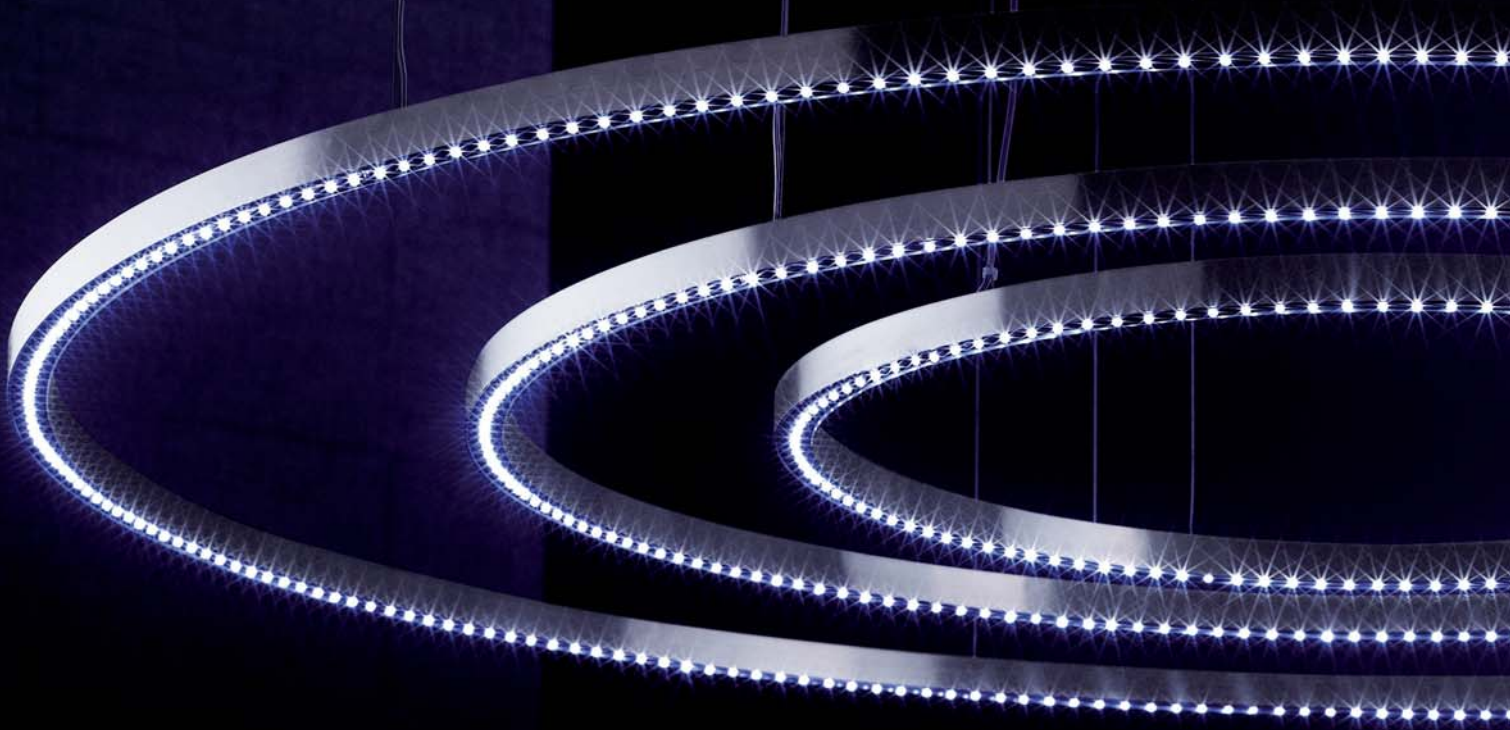

LED AURA

Giancarlo Tintori

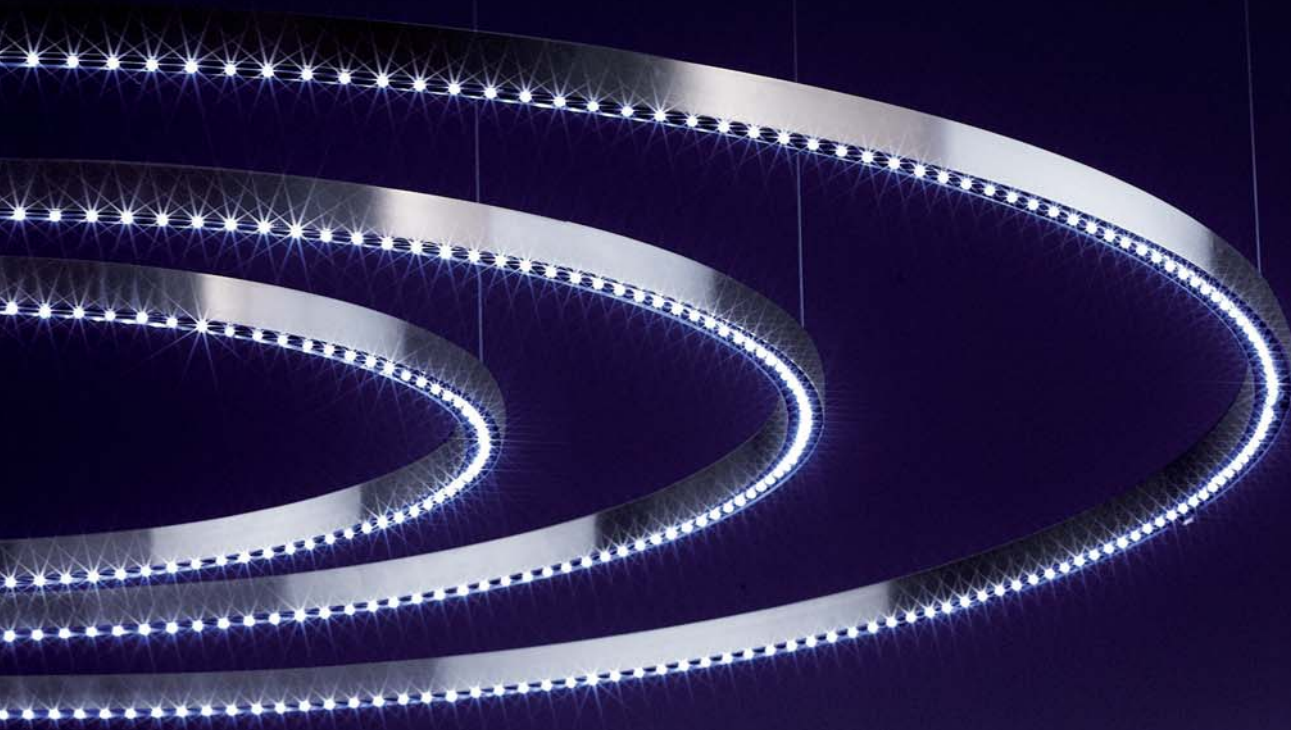



(A)
Esempio di installazione
Example of installation

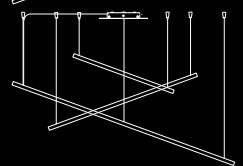
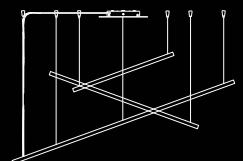
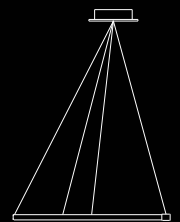
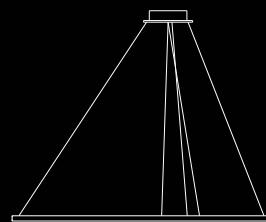
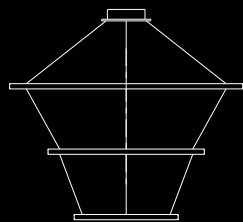
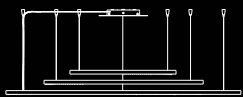
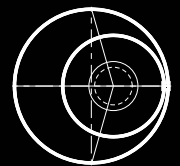
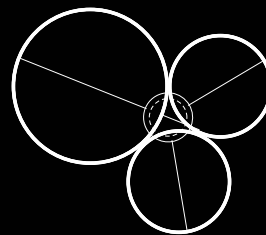
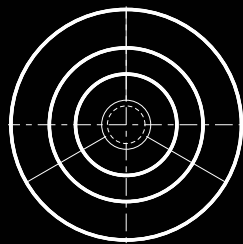
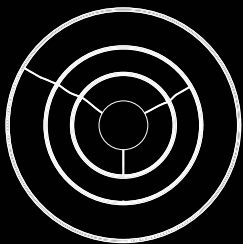



LED AURA: purezza, eleganza, effetto scenico. LED AURA è una lampada a sospensione semplice ma di sicuro effetto adatta a tutti gli ambienti dove si richiede un'illuminazione che non sia solo funzionale ma che conferisce pregio e stile. Il sistema di illuminazione diretta a LED assicura un'intensità luminosa costante e gradevole. Può essere installata a diverse altezze ed inclinazioni allungando o accorciando i cavi di sospensione (A).

Per installazioni su soffitti in muratura è necessario utilizzare i rosoni (Ceiling Rose) inclusi tra gli accessori; oppure è possibile l'installazione a sospensione su controsoffitto in cartongesso mediante il rosone copriforo (Controsoffitto Plate).

Caratteristiche tecniche:

Corpo in alluminio verniciato AISI 304

Cavi di sospensione in acciaio.

Quattro colori disponibili.

Alimentazione elettronica per LED Relco a corredo per versione "completa", a richiesta per gli altri modelli.

AURA LED: pure, elegant, sure to impress. AURA LED is a simple yet impressive pendant lamp, suitable for every room requiring lighting that is not only functional but enhancing and adds style as well. This LED direct lighting system provides uniform and pleasant light intensity. It can be installed at different heights and inclinations by extending or shortening the suspension cables (A).

For installation on masonry ceilings, it requires a ceiling rose, which is included with the accessories; it can also be installed on plaster-wall false ceilings using a false ceiling plate.

Technical features:

Painted aluminium body AISI 304

Steel suspension cables

4 available colours.

Electronic power supply for LED Relco is supplied with the "full" version, optional for other models.



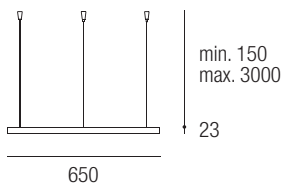

LED AURA 6

Codice	Code	Euro
800002	CELL (WH)	350,00
800001	CELL (BK)	350,00
800226	CELL (GR)	350,00
800003	CELL (RD)	350,00

Materiali Body

Bianco (WH)
White (WH)

Nero (BK)
Black (BK)

Grigio (GR)
Grey (GR)

Rosso (RD)
Red (RD)

Peso Weight

2,7 Kg

Fonti luminose Light source

>30.000 h.

123 LED = 6,5W LED 12V 3000K lens 90°

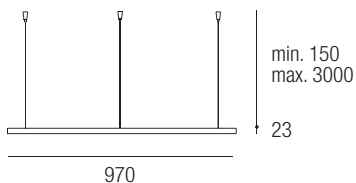
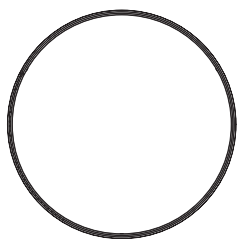

LED AURA 9

Codice	Code	Euro
800102	CELL (WH)	500,00
800101	CELL (BK)	500,00
800026	CELL (GR)	500,00
800103	CELL (RD)	500,00

Materiali Body

Bianco (WH)
White (WH)

Nero (BK)
Black (BK)

Grigio (GR)
Grey (GR)

Rosso (RD)
Red (RD)

Peso Weight

3,8 Kg

Fonti luminose Light source

>30.000 h.

183 LED = 16W LED 12V 3000K lens 90°

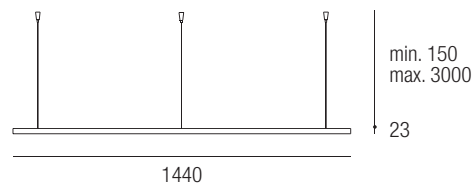
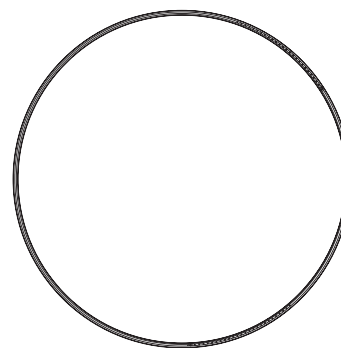

LED AURA 15

Codice	Code	Euro
800202	CELL (WH)	600,00
800201	CELL (BK)	600,00
800126	CELL (GR)	600,00
800203	CELL (RD)	600,00

Materiali Body

Bianco (WH)
White (WH)

Nero (BK)
Black (BK)

Grigio (GR)
Grey (GR)

Rosso (RD)
Red (RD)

Peso Weight

5,5 Kg

Fonti luminose Light source

>30.000 h.

270 LED = 21,5W LED 12V 3000K lens 90°





ACCESSORI - ACCESSORIES

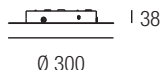

Collegare i prodotti agli alimentatori avendo cura di non superare la potenza.

To connect the products to the power supply please take care and respect the power.

AURA CEILING ROSE 100W

Codice Code Euro
805026 **220,00**

Peso Weight
1,7 Kg

AURA CEILING ROSE 50W

Codice Code Euro
805126 **180,00**

Peso Weight
1,85 Kg

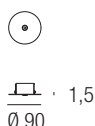
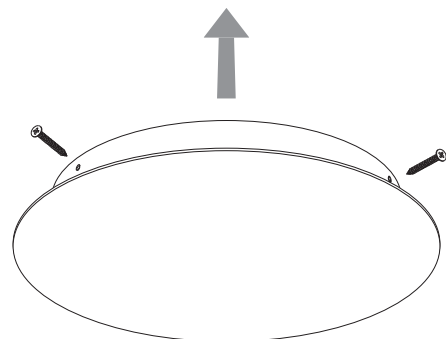
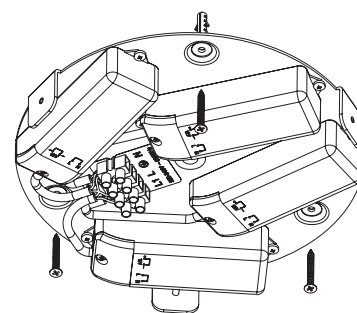

AURA CONTROSOFFITTO PLATE

Codice Code Euro
805226 **42,32**

Peso Weight
0,15 Kg

cavi di sospensione regolabili da 500 a 1500 mm.

adjustable suspension cable length 500-1500 mm.





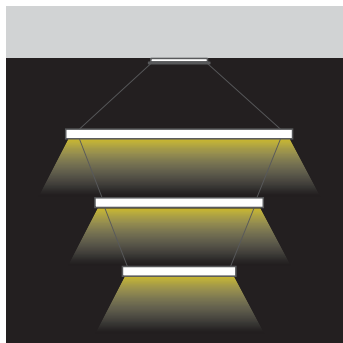
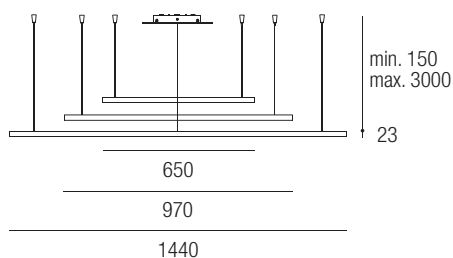
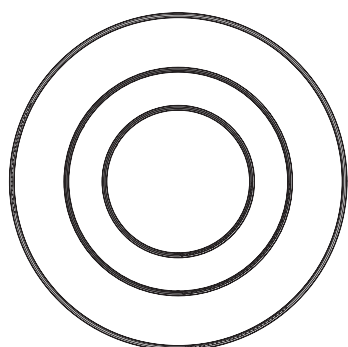

LED AURA COMPLETA - Single Emission

Codice	Code	Euro
802002	CELL (WH)	1514,50
802001	CELL (BK)	1514,50
802017	CELL (GR)	1514,50
802003	CELL (RD)	1514,50

Materiali Body

 **Bianco (WH)**
White (WH)

 **Nero (BK)**
Black (BK)

 **Grigio (GR)**
Grey (GR)

 **Rosso (RD)**
Red (RD)

Peso *Weight*
12 Kg

Fonti luminose *Light source*



>30.000 h.

576 LED = 44W LED 12V 3000K lens 90°

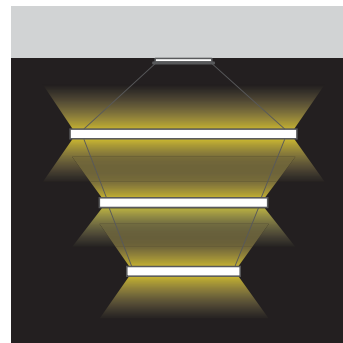

LED AURA COMPLETA - Double Emission

Codice	Code	Euro
801802	CELL (WH)	2275,00
801801	CELL (BK)	2275,00
801817	CELL (GR)	2275,00
801803	CELL (RD)	2275,00

Materiali Body

 **Bianco (WH)**
White (WH)

 **Nero (BK)**
Black (BK)

 **Grigio (GR)**
Grey (GR)

 **Rosso (RD)**
Red (RD)

Peso *Weight*
12 Kg

Fonti luminose *Light source*



>30.000 h.

1146 LED = 44+44W LED 12V 3000K lens 90°

Far attenzione al cablaggio UP e DOWN nel caso di accensioni separate dei LED superiori dai LED inferiori. Per avere un'unica accensione del prodotto, cavallottare L1 ed L.

Pay attention to UP and DOWN wiring if you want to light separately the Up LED from the Down ones. To light on Up and Down together, link L1 and L.







LED FORMA ha un design semplice, pulito, lineare. Una lampada a sospensione dalla forma allungata e affusolata ai due estremi per indirizzare la luce sulle superfici in modo puntuale. Un'illuminazione d'accento, ideale per i tavoli da pranzo in ambienti residenziali, alberghieri e di ristoro che ben si inserisce in arredi moderni e di classe.

Caratteristiche tecniche:

Corpo in metallo
Finitura verniciata bianco opaco RAL9010 o nero opaco RAL9005.
Trasformatore elettronico (Relco) incorporato nel rosone a soffitto.
Lampada LED a corredo.

FORMA LED has a simple, clean, linear design. It is a pendant lamp with a long shape, tapered at both ends to direct light markedly onto surfaces. It provides accent lighting, ideal for dining tables in homes, hotels and restaurants, and fits in well with modern, classy furnishing.

Technical features:

Metal body
RAL9010 matt white painted finish or RAL9005 matt black.
Electronic transformer (Relco) built into the ceiling rose.
LED lamp included.

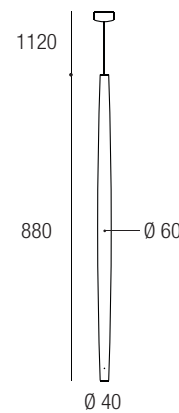
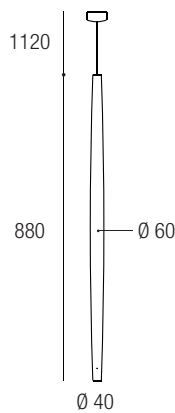

LED FORMA

Codice Code Euro
690102 CELL 203,39

Materiali Body



Bianco (WH)
White (WH)

Peso Weight

2 Kg

Fonti luminose Light source



>30.000 h.

3W POWERLED 3000K lens 30°

LED FORMA

Codice Code Euro
690101 CELL 203,39

Materiali Body



Nero (BK)
Black (BK)

Peso Weight

2 Kg

Fonti luminose Light source



>30.000 h.

3W POWERLED 3000K lens 30°

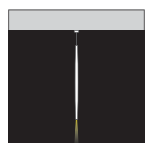

LED **3W** = **15W HALO**



LED **3W** = **15W HALO**



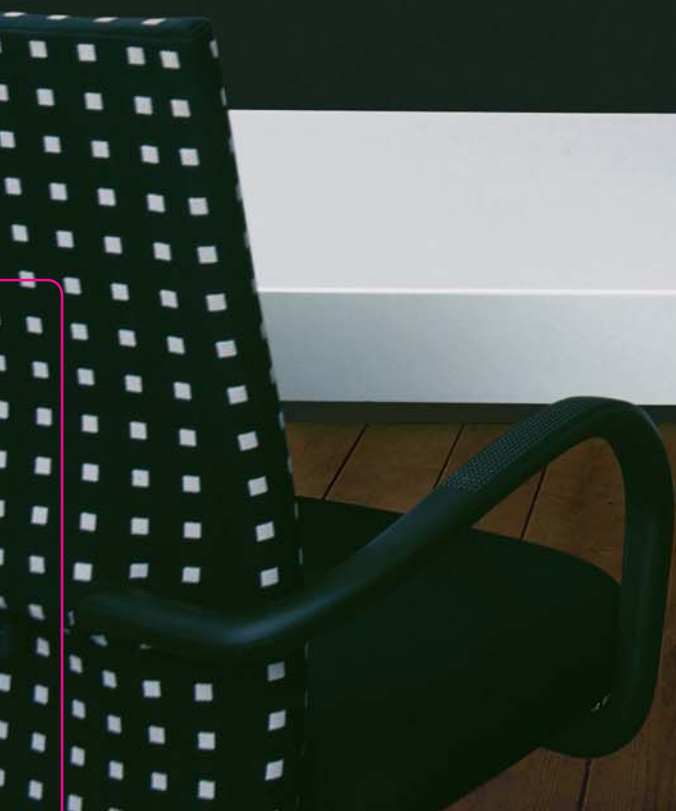



OFEK è un'originale lampada da soffitto orientabile, moderna, capace di inclinarsi e ruotare a 360°. Una lampada versatile, perfetta per i piani di lavoro, può emettere una luce diffusa oppure direzionale grazie all'aggiunta di uno schermo (Ofek Reflector). L'asta di sospensione è regolabile in altezza per meglio adattarsi ad ogni esigenza.

Caratteristiche tecniche:

Alimentatore elettronico e interruttore (Relco) incorporati.
Struttura in metallo cromato e diffusore tubolare in policarbonato trasparente rigato. Lampada fluorescente tipo T5 Leuci.

OFEK is a unique, modern, direction-adjustable ceiling lamp that can be inclined and turned by 360°. This is a versatile lamp, perfect for work surfaces, that can emit diffused or directed light thanks to an added screen (Ofek Reflector). The suspension rod is height-adjustable, to adapt to your every need.

Technical features:

Built-in electronic power supply unit and switch (Relco).
Chrome-plated metal structure and ribbed transparent polycarbonate tubular shade. Leuci T5 fluorescent lamp.

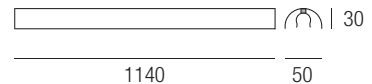
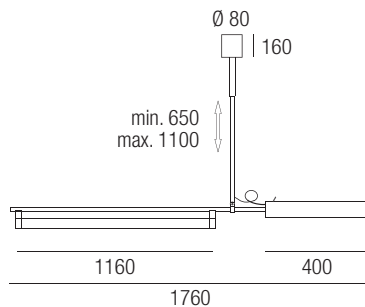

ACCESSORIO ACCESSORY

OFEK

Codice Code Euro
410004 CELL 694,79

Materiali Body



Cromo (CR)
Chrome (CR)

Peso Weight
4,7 Kg

Fonti luminose Light source

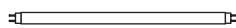

54W T5 G5 230V 4000K

OFEK REFLECTOR

Codice Code Euro
415015 25,94

Materiali Body



Alluminio lucido (AB)
Brilliant aluminium (AB)

Peso Weight
0,45 Kg

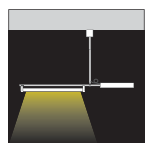





LED QUEEN'S è una lampada a sospensione elegante e ricercata la cui struttura metallica è rivestita da dischi di alluminio a specchio, agganciati mediante un sistema a calamita. LED QUEEN'S come una pelle magica, riflette l'ambiente circostante creando giochi di luce e forme. Un ulteriore elemento distintivo di pregio è la doppia emissione del fascio luminoso. Infatti, emette una luce indiretta a grazie a 3 sorgenti LED GU10 e diretta con una lampada GLOBO LED E27. E' una lampada di prestigio adatta sia a grandi spazi che ad abitazioni, loft, aree comuni.

Disponibile in due misure.

Caratteristiche tecniche:

- Corpo in alluminio lucido
- Cavi di sospensione in acciaio
- Sorgenti LED a corredo

QUEEN'S LED is an elegant and sophisticated pendant lamp featuring a metal structure lined with mirror-finish aluminium discs that stay on with magnets. QUEEN'S LED is like a magic skin, it reflects the surrounding environment, creating a play of light and shape. An additional distinguishing feature is its dual light output. In fact, it emits an indirect light through its 3 GU10 LED light sources, as well as direct light through an E27 GLOBO LED lamp. This is a top quality lamp that is as suitable for large spaces as it is for homes, lofts, common areas.

Available in two sizes.

Technical features:

- Glossy aluminium body
- Steel suspension cables
- LED sources included

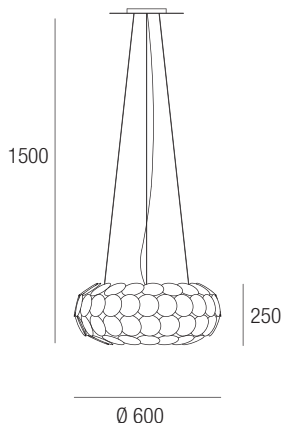

LED QUEEN'S 60

Codice	Code	Euro
640015/LED	S+L	1359,54

Materiali *Body*



Alluminio lucido (AB)
Brilliant aluminium (AB)

Peso *Weight*

12,95 Kg

Fonti luminose *Light source*



>30.000 h.



01) 3x 1,7W G9 220÷240 2700K lens 145°

02) 16W GLOBO LED E27 220÷240 3000K lens 300°

LED **1,7W** = **20W** classic

LED **16W** = **100W** classic

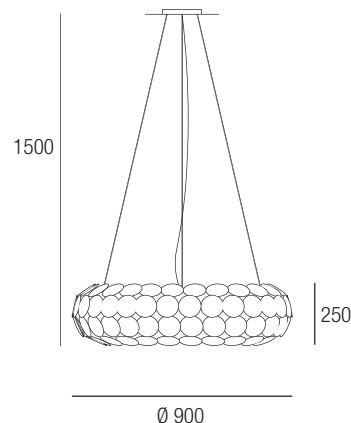

LED QUEEN'S 90

Codice	Code	Euro
640115/LED	S+L	1882,34

Materiali *Body*



Alluminio lucido (AB)
Brilliant aluminium (AB)

Peso *Weight*

19 Kg

Fonti luminose *Light source*



>30.000 h.



01) 3x 1,7W G9 220÷240 2700K lens 145°

02) 16W GLOBO LED E27 220÷240 3000K lens 300°

LED **1,7W** = **20W** classic

LED **16W** = **100W** classic



cavi di sospensione regolabili da 500 a 1500 mm.
adjustable suspension cable length 500-1500 mm.







BRILLIANCE.com

PHILIPS

LOFTS

SPAZI MINIMALISTI

Sur Mars

architetture minimaliste

inside minimalist interiors

Exploring America from the Air

minimalism MAXIMALISM

CONTEMPORARY DETAILS





LED QUINTA è un sistema di illuminazione per interni a sospensione molto pratico, funzionale di design moderno e minimale. Ideale per illuminare uffici e postazioni lavoro e reception ben si presta ad ambienti commerciali e contract.

La possibilità di scegliere e cambiare il colore delle "quinte" disponibili anche in colorazioni su misura, ne fa una lampada originale e innovativa tanto più che offre la possibilità di orientare ogni singola ottica tramite un sistema a snodo $\pm 45^\circ$, e $\pm 90^\circ$ sull'asse orizzontale.

Caratteristiche tecniche:

Diffusori in metacrilato traslucido

Per ottenere una lampada completa è necessario abbinare al codice lampada il codice diffusore: Quinta 2 Plex large.

Alimentatore elettronico Relco incorporato.

Lampada LED leuci a corredo.

QUINTA LED is a very practical, functional lighting system for interiors, with a modern and minimal design. It is ideal for lighting offices and work and reception stations, and is very well-suited for commercial and contract environments.

The possibility of choosing and changing the colour of the "backstage wings", also available with custom-made colours, makes it an original and innovative lamp that uses a joint system to adjust the direction of every single optic by $\pm 45^\circ$ and $\pm 90^\circ$, in relation to the horizontal axis.

Technical features:

Translucent methacrylate shades

To obtain a complete lamp you are required to provide the shade code to the lamp code: Quinta 2 Plex large.

Built-in Relco electronic power supply unit.

Leuci LED lamp included.



Sospensione | Suspension





cavi di sospensione regolabili
da 500 a 1500 mm.
*adjustable suspension
cable length 500-1500 mm.*



Orientabilità
Adjustability

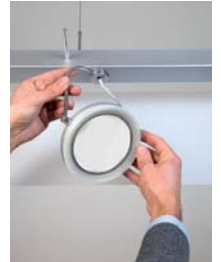

QUINTA SPOT S

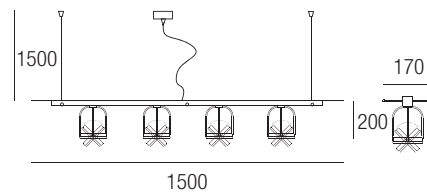

LED QUINTA SPOT S

Codice	Code	Euro
460824	CELL	712,53
460924	CELL	712,53

Materiali *Body*



Argento/Cromo (AG/CR)
Silver/Chrome (AG/CR)

Peso *Weight*
5,55 Kg

Fonti luminose *Light source*

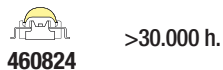

460824
4x27W POWERLED 700mA 3000K lens 130°

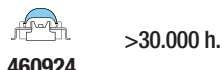

460924
4x27W POWERLED 700mA 6000K lens 130°

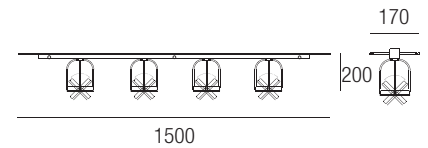

LED QUINTA SPOT C

Codice	Code	Euro
461024	CELL	873,76
461124	CELL	873,76

Materiali *Body*



Argento/Cromo (AG/CR)
Silver/Chrome (AG/CR)

Peso *Weight*
5,45 Kg

Fonti luminose *Light source*

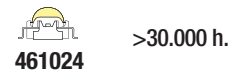

461024
4x27W POWERLED 700mA 3000K lens 130°

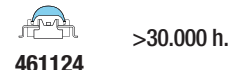

461124
4x27W POWERLED 700mA 6000K lens 130°



QUINTA SPOT C



LED **27W** = **100W HALO**





Sospensione | Suspension



Parete | Wall

LED QUINTA

Adrian Peach

Accessorio per Quinta Spot Accessories for Quinta Spot

Per ottenere una lampada completa è necessario abbinare al codice lampada il codice diffusore.
To obtain a complete lamp the shade code must be coupled to the lamp code.

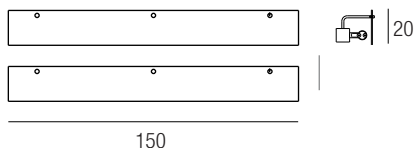
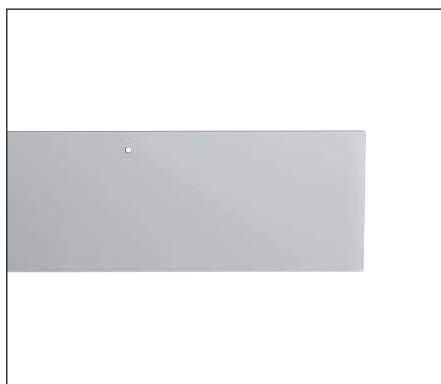

LED QUINTA 2 PLEX LARGE

Codice Code Euro
465302 216,58

Per codice For code
460824 - 460924 - 461024 - 461124

Materiali Body



Bianco (WH)
White (WH)

Peso Weight
3 Kg

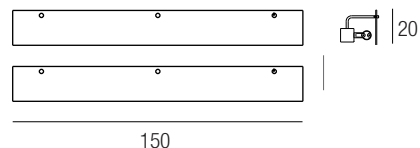
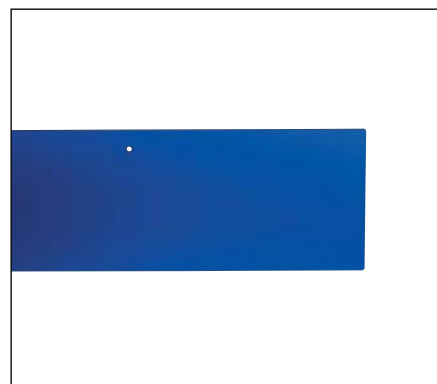

LED QUINTA 2 PLEX LARGE

Codice Code Euro
465313 216,58

Per codice For code
460824 - 460924 - 461024 - 461124

Materiali Body



Blu (BL)
Blue (BL)

Peso Weight
3 Kg

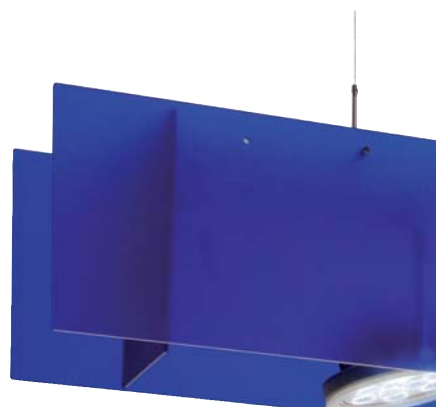

Sospensione | Suspension







LED SFERA è una sospensione, discreta, elegante, che può essere installata da sola o in combinazione di due o più pezzi. Classica ed esteticamente piacevole ben si sposa in ambienti moderni. La luce è orientata e diffusa verso il basso. Un'ulteriore caratteristica è data dalla limitata temperatura che consente, dove fosse necessario, un'installazione anche ad altezze ridotte quali ad esempio tavoli per ristoranti.

Caratteristiche tecniche:

Corpo, anello, riflettore e rosone in lamiera di acciaio tornito in lastra e lavorati meccanicamente

Piattello rosone ed attacco a parete in lamiera di acciaio tranciati freddo.

Finitura superficiale cromata con le parti riflettenti verniciate a liquido di colore bianco lucido RAL 9003

Schermo led in tecnopolimero plastico trasparente con finitura satinata sul solo lato interno

Alimentatore elettronico Relco incorporato

SFERA LED is a pendant, discreet, elegant lamp that can be installed on its own or in combination with two or more pieces. Classic and aesthetically appealing, it fits in well in modern settings. The light is directed and diffused downwards. It has the additional feature of having a limited surface temperature, which allows it to be installed at low heights, if required, such as over restaurant tables, for example.

Technical features:

Mechanically processed, turned sheet steel body, ring, reflector and ceiling rose

Ceiling rose plate and wall fitting in cold-sheared sheet metal.

Chrome-plated surface finish with liquid-painted reflecting parts in RAL 9003 glossy white

Transparent plastic technopolymer LED screen with satin-finish only on inner side

Built-in Relco electronic power supply unit

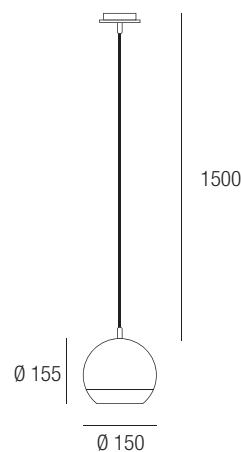

LED SFERA

Codice	Code	Euro
136/S1	CELL	286,65

Materiali *Body*



Cromo (CR)
Chrome (CR)

Peso *Weight*

0,75 Kg

Fonti luminose *Light source*



>30.000 h.

5W LED 3000K Beam 120° CRI 90



LED **5W** = **40W** classic

230V - 50Hz





Colori disponibili - Available colors:

Interno
Interior

Esterno
Exterior

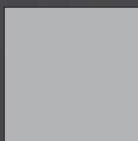

cavi di sospensione regolabili
da 500 a 1500 mm.
adjustable suspension
cable length 500-1500 mm.



LED STILNOVO è una sospensione di grandi dimensioni, sobria ma elegante, arricchisce ogni ambiente e dona una calda luce diffusa. Ideale in locali, ristoranti e nel contract. Ben si inserisce anche in contesti abitativi e si adatta a ciascuno stile grazie alla sua forma semplice, pulita ma di sicuro effetto. Disponibile nei colori: grigio, nero e oro.

Caratteristiche tecniche:

Materiale "Acrilite®"

Dispositivo di regolazione dei cavi di sospensione da min. 500 mm. a max. 1500 mm.

Sorgente luminosa a LED ad illuminazione "diretta" con attacco E27.

STILNOVO LED is a large-size pendant lamp, with a sober yet elegant style, that enhances any room and provides a warm, diffused light. It is ideal for lounges, restaurants and contract environments. It is also very suitable for living facilities and adapts to any style thanks to its simple shape, which is minimal yet sure to impress. Available in the following colours: grey, black and gold.

Technical features:

"Acrilite®" material

Suspension cable adjusting device from a min. of 500 mm to a max. of 1500 mm.

"Direct" light LED light source with E27 fitting.

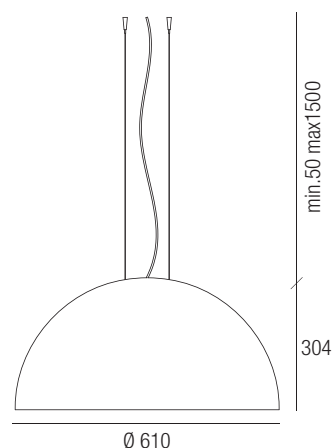

LED STILNOVO

Codice	Code	Euro
240002	S+L	941,85
240102	S+L	941,85

Materiali Body

Interno - Interior

Esterno - Exterior



Grigio (GR)
Grey (GR)

Peso Weight

3,750 Kg

Fonti luminose Light source



>30.000 h.

240002

16W GLOBO LED E27 220÷240V 6000K lens 300°



>30.000 h.

240102

16W GLOBO LED E27 220÷240V 3000K lens 300°

LED STILNOVO

Codice	Code	Euro
240003	S+L	941,85
240103	S+L	941,85

Materiali Body

Interno - Interior

Esterno - Exterior



Nero (BK)
Black (BK)

Peso Weight

3,750 Kg

Fonti luminose Light source



>30.000 h.

240003

16W GLOBO LED E27 220÷240V 6000K lens 300°



>30.000 h.

240103

16W GLOBO LED E27 220÷240V 3000K lens 300°

LED STILNOVO

Codice	Code	Euro
240004	S+L	941,85
240104	S+L	941,85

Materiali Body

Interno - Interior

Esterno - Exterior



Oro (GD)
Gold (GD)

Peso Weight

3,750 Kg

Fonti luminose Light source



>30.000 h.

240004

16W GLOBO LED E27 220÷240V 6000K lens 300°



>30.000 h.

240104

16W GLOBO LED E27 220÷240V 3000K lens 300°



LED 16W = 100W classic







LED ZENO è una lampada decorativa a sospensione per interni.

Dalla forma sobria, semplice e geometrica, si adatta ad ogni ambiente. E' leggera, infrangibile, ed è disponibile sia nella versione quadrata che rettangolare e nei colori bianco o nero. Emette una luce viva pura senza compromessi formali, rigorosa e calda.

Caratteristiche tecniche:

Cavi di sospensione da min. 500 mm. a massimo 1500 mm.

LED ad illuminazione "diretta" con attacco E27.

Struttura in metallo verniciato con possibilità di orientare ogni singola ottica tramite il sistema a snodo $\pm 45^\circ$.

Lampada LED leuci a corredo.

ZENO LED is a decorative pendant lamp for interiors.

It features a sober, simple and geometric shape that adapts to every setting. It is light, shatter-proof and available in a square or rectangular version, in white or black. It emits a vivid, pure light without compromising its shape, that is exact and warm.

Technical features:

Suspension cables from a min. of 500 mm to a max. of 1500 mm.

"Direct" light LED with E27 fitting.

Painted metal structure with the possibility of adjusting the direction of every single optic through the $\pm 45^\circ$ joint system.

Leuci LED lamp included.



cavi di sospensione regolabili da 500 a 1500 mm.
adjustable suspension cable length 500-1500 mm.



Orientabilità
Adjustability



Corpo: in metallo verniciato bianco RAL 9010 opaco.

Body: Metal with RAL 9010 matt white paint.





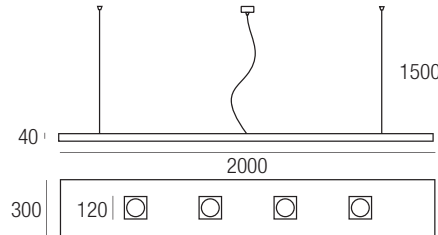
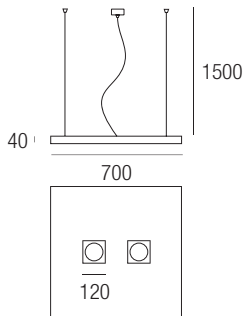

LED ZENO Q

Codice Code Euro
771402 CELL 1375,40

Materiali Body



Bianco (WH)
White (WH)

Peso Weight
0,7 Kg

Fonti luminose Light source



>30.000 h.

771402
 2x27W POWERLED 700mA 3000K lens 130°

LED ZENO R

Codice Code Euro
771502 CELL 2173,60

Materiali Body



Bianco (WH)
White (WH)

Peso Weight
0,7 Kg

Fonti luminose Light source



>30.000 h.

771502
 4x27W POWERLED 700mA 3000K lens 130°

A richiesta - On request

NERO - BLACK

Materiali Body



Nero (BK)
Black (BK)

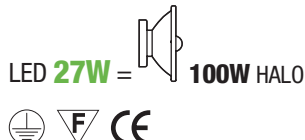
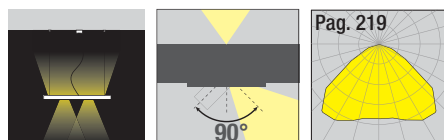





Apparecchio di illuminazione a fluorescenza per applicazioni a luce diffusa. La forma classica consente a questi apparecchi di illuminazione di poter essere collocata in molteplici tipologie di installazione siano esse residenziali (cucine, aree di servizio) o terziarie (uffici direzionali, open space, aree comuni, negozi, magazzini) dove sia necessario avere un buon contributo di luce diretta ed un altrettanto importante contributo di luce indiretta riflessa dal soffitto. È disponibile in due finiture; deve essere utilizzata per sole applicazioni a sospensione e, al fine di poter gestire correttamente la luminanza a soffitto, si consiglia una distanza minima tra il corpo illuminante ed il soffitto stesso non inferiore a 100/110cm.

Corpo: in alluminio estruso con finiture anodizzata naturale o satinata, terminali di chiusura in alluminio stampato con finitura verniciata, vano di alimentazione in rete d'acciaio forata.

Diffusore: in Polimetilmetacrilato (PMMA) estruso con geometria interna frangiluce

Alimentazione: Alimentatore elettronico Relco (non dimmerabile) alloggiato nel corpo lampada

Sorgenti luminose: Leuci con attacco G5

Fluorescent illuminated device for appliance with diffused lighting. The standard form allows these luminous appliances to be collocated in numerous types of installments either residential (kitchens, service areas) or tertiary areas (open space, warehouses, stores) where it is necessary to have a large amount of direct lighting other than an equally significant amount of indirect lighting that reflects from the ceiling. It is available in two textures; it must be used solemnly for applications with suspensions and, in order to correctly adjust the luminosity on ceiling, the minimum distance between the illuminant body and the ceiling is advised to be 100/110cm.

Body: extruded aluminum with anodized textures either natural or glazed, cable heads used for closure in printed aluminum with varnished texture, compartment of power supply in a net of perforated steel.

Diffuser: Polymethyl methacrylate (PMMA) extruded with an internal geometry of light breaker.

Alimentation: Relco electric feeder (not dimmable) placed in the body of the lamp.

Luminous power supplies: Leuci with G5 binding

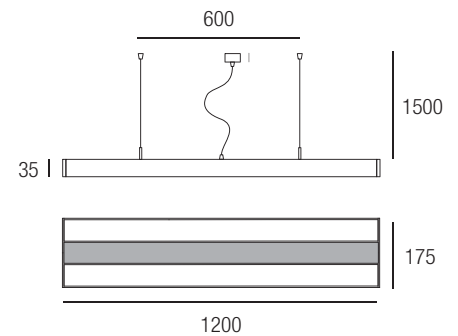

LINE 2 S 120

Codice	Code	Euro
400721	CELL (AA)	481,85
400726	CELL (AA)	514,61

Materiali Body



Alluminio (AA)
Aluminium (AA)



Argento (AG)
Silver (AG)

Peso Weight

5,1 Kg

Fonti luminose Light source

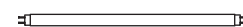

2x54W G5 T5 230V 4000K



230V - 50Hz



HALO**Cod. 444056.0101 - 2700K**

Lampada Leuci Halo GLS 70W - E27 intercambiabile con la classica lampada incandescente
Halo GLS Leuci lamp with 70W - E27 interchangeable with the standard lamp

FLUO**Cod. 600340.0101 - 2700K**

Lampada Leuci Fluotronic 21W - E27 intercambiabile con la classica lampada incandescente
Fluotronic Leuci lamp with 21W - E27 interchangeable with the standard lamp

Cod. 600350.0101 - 2700K

Lampada Leuci Fluotronic 25W - E27 intercambiabile con la classica lampada incandescente
Fluotronic Leuci lamp with 25W - E27 interchangeable with the standard lamp

LED**Cod. 555130.0101 - 3000K**

Lampada Leuci LED 16W - E27 intercambiabile con la classica lampada incandescente
LED Leuci lamp with 16W - E27 interchangeable with the standard lamp



LED PLEX è una lampada a sospensione realizzata in plexiglass. Dal design semplice e moderno ben si inserisce in ogni ambiente domestico, illuminando con luce calda e diffusa tavoli da pranzo, zone giorno, soggiorni. Ideale anche per applicazioni contract.

Disponibile in tre finiture di colore e in due dimensioni: grigio trasparente, grigio fumè e rosso

Caratteristiche tecniche:

cavi di sospensione e struttura in acciaio

LED Plex is a suspension lamp made of plexiglass. Featuring a simple and modern design, it fits well in any home, lighting dining tables, living areas, living rooms with a warm, diffused light. Also ideal for non-residential spaces.

Available in three colours and two sizes: transparent grey, smoky grey and red

Technical features:

suspension cables and steel frame

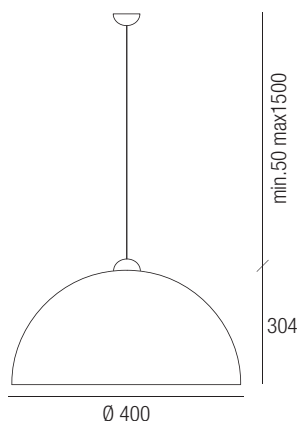

LED PLEX 40

Codice	Code		Euro
700/S40GRFUME	S (GR-FU)		305,5
700/S40ROSSO	S (RD)		305,5
700/S40GRTRAS	S (GR-TR)		305,5

Materiali *Body*

 **700/S40GRFUME**
Grigio fumè (GR-FU)
Smoke Grey (GR-FU)

 **700/S40ROSSO**
Rosso (RD)
Red (RD)

 **700/S40GRTRAS**
Grigio trasparente (GR-TR)
Transparent Grey (GR-TR)

Peso *Weight*
0,7 Kg

Fonti luminose *Light source*

E27 230÷240V 50Hz

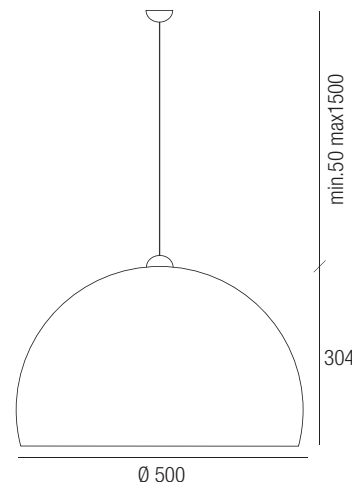

LED PLEX 50

Codice	Code		Euro
700/S50GRFUME	S (GR-FU)		357,5
700/S50ROSSO	S (RD)		357,5
700/S50GRTRAS	S (GR-TR)		357,5

Materiali *Body*

 **700/S50GRFUME**
Grigio fumè (GR-FU)
Smoke Grey (GR-FU)

 **700/S50ROSSO**
Rosso (RD)
Red (RD)

 **700/S50GRTRAS**
Grigio trasparente (GR-TR)
Transparent Grey (GR-TR)

Peso *Weight*
0,9 Kg

Fonti luminose *Light source*

E27 230÷240V 50Hz







COORDINATI



COORDINATED

da
from

84

a
to

127





LED CORALLO

Relcogroup engineering

LED CORALLO è una serie di lampade in vetro opale e corpo in acciaio adatte a tutti gli ambienti. Disponibile nella versione sospensione, da parete, da terra e da tavolo. Una famiglia di coordinati, semplici ed eleganti, adatti ad ogni stile.

La forma del diffusore quadrata e aperta ai lati dona una luce calda e diffusa.

Caratteristiche tecniche:

Corpo in acciaio e vetro opale

Portalampada in materiale termoplastico

Cablaggio completo di morsettiera a 2 poli (sospensione); completo di morsettiera a 3 poli (applique); completo di cavo, spina e interruttore (tavolo e piantana)

CORALLO LED is a series of opal glass lamps with steel body, suitable for every type of setting. It is available in pendant, wall, floor and table versions. A family of simple and elegant coordinates, suitable for every style.

The shape of the open-sided square shade provides warm and diffused light.

Technical features:

Steel and opal glass body

Thermoplastic lamp holder

Wiring includes 2-pole terminal board (suspension); includes 3-pole terminal board (wall lamp); includes cable, plug and switch (table and floor lamp)



Coordinati | Coordinated

LED CORALLO APPLIQUE

Relcogroup engineering



Parete | Wall

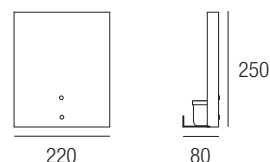

LED CORALLO APPLIQUE

Codice Code Euro
2276/A-1/LED S+L 156,98

Materiali Body



Argento/Bianco (AG/WH)
Silver/White (AG/WH)

Peso Weight
0,60 Kg

Fonti luminose Light source

 **>30.000 h.**

8W LED E27 230÷240 3000K lens 300°

LED **8W** =  **60W** classic





Terra | Floor

LED CORALLO PIANTANA

Relcogroup engineering

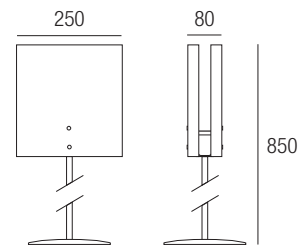

LED CORALLO PIANTANA

Codice *Code*
2276/LED S+L Euro **375,51**

Materiali *Body*



Argento/Bianco (AG/WH)
Silver/White (AG/WH)

Peso *Weight*
5,30 Kg

Fonti luminose *Light source*



>30.000 h.

8W LED E27 230÷240 3000K lens 300°

LED **8W** = **60W** classic



lighting technologies

Coordinati | Coordinated

LED CORALLO SOSPENSIONE

Relcogroup engineering



Sospensione | Suspension

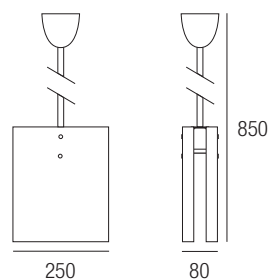

LED CORALLO SOSPENSIONE

Codice Code Euro
2276/S-1/LED S+L 265,72

Materiali Body



Argento/Bianco (AG/WH)
Silver/White (AG/WH)

Peso Weight
2,20 Kg

Fonti luminose Light source



>30.000 h.

8W LED E27 230÷240 3000K lens 300°

LED **8W** = **60W** classic



lighting technologies



Tavolo | Table

LED CORALLO TAVOLO

Relcogroup engineering

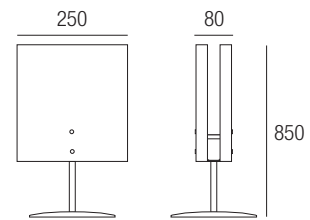

LED CORALLO TAVOLO

Codice	Code	Euro
2276/L-1/LED	S+L	208,00

Materiali *Body*



Argento/Bianco (AG/WH)
Silver/White (AG/WH)

Peso *Weight*

0,60 Kg

Fonti luminose *Light source*



>30.000 h.

4W LED E14 230÷240 3000K lens 300°

LED **4W** = **40W** classic



lighting technologies





Le LED FLEXA sono lampade da interni, classiche e moderne insieme disponibili in diverse misure e con diverse caratteristiche così da inserirsi in qualsiasi ambiente e adattarsi a qualsiasi esigenza di illuminazione. Con Led Flexa illumini arredando.

I paralumi sono tutti realizzati in tessuti hi-tech innovativi (Bianco Melange - Nero Melange) o cotone naturale (bianco, écru, nero, rosso) mentre le strutture sono in metallo cromato.

Queste lampade belle e versatili sono adatte all'illuminazione di ambienti di grandi dimensioni, soggiorni, tavoli da pranzo o da lavoro. Semplici da installare, prevedono la possibilità di decentrare il punto luce così da raggiungere sempre la posizione desiderata.

Il modello Flexa S Maxi è una lampada a sospensione con paralume di grandi dimensioni (diametro 70cm), mentre la Flexa S Mini è un modello analogo ma con paralume di dimensioni inferiori (Ø35cm).

La versione Flexa S è una lampada a sospensione con asta allungabile e con i movimenti di rotazione dell'attacco a soffitto sull'asse verticale. Estensione dell'asta da 1 a 2m e saliscendi dei cavi di sospensione in acciaio. Una lampada davvero flessibile perché consente di portare la luce dove serve senza doversi preoccupare della posizione del punto luce. Infatti il cavo elettrico è lungo circa 3m e termina con una spina che consente di collegarsi a prese di corrente.

Flexa W è una lampada da parete con asta allungabile e braccio fissato a parete che può ruotare sull'asse verticale e orizzontale. È disponibile anche con l'accessorio ceiling rose per Flexa S e Flexa W, nel caso che l'alimentazione non arrivi tramite la presa a muro ma provenga da soffitto o da parete.

Infine il modello Flexa F, FF sono lampade da terra con asta telescopica flessibile ed allungabile in ottone finitura nichel satinato. Grazie ad un peso che scorre lungo l'asta telescopica è possibile modificare l'inclinazione della stessa e quindi l'altezza del paralume.

Queste lampade sono adatte all'illuminazione di ambienti di grandi dimensioni, soggiorni, tavoli da pranzo o da lavoro.

Lampada E27 LED compresa.

FLEXA LED lamps for interiors are both classic and modern at the same time, available in different sizes and with different characteristics so they can be installed in any setting and adapt to any lighting need. With Flexa Led you get lighting and décor at the same time.

The lamp shades are made with innovative hi-tech fabrics (White Melange - Black Melange) or natural cotton (white, ecru, black, red), while the structures are made with chrome-plated metal.

These pretty and versatile lamps are suitable to light large rooms, living rooms, dining or work tables. They offer easy installation and the possibility of moving the position of the lighting point to reach the required position.

The Flexa S Maxi model is a pendant lamp with a large-size lampshade (with a diameter of 70cm), while Flexa S Mini is a similar model with a smaller lampshade (Ø35cm).

The Flexa S version is a pendant lamp with an extendible rod that can rotate along its vertical axis, from a ceiling fitting. The rod can extend from 1 to 2 m and the length of the steel suspension cables can be set longer or shorter. This lamp is truly flexible because it allows you to direct light where it is needed, without having to worry about the position of the lighting point. In fact, the electric cable, which is about 3 metres long, ends with a plug so that it can be connected to current sockets.

Flexa W is a wall lamp with an extendible rod and wall bracket that can rotate on its vertical and horizontal axis. It is also available with a ceiling rose accessory for Flexa S and Flexa W, if the power supply is not provided by a wall socket but comes from the ceiling or the wall.

Lastly, the Flexa F, FF models are floor lamps with flexible, extendible telescopic satin nickel-finish brass rods. Thanks to a weight that runs along the telescopic rod, it is possible to change the inclination and therefore the height of the lampshade.

These lamps are suitable to light large rooms, living rooms, dining or work tables.

E27 LED lamp included.



A differenza degli altri modelli, Flexa S Maxi non ha un codice paralume e uno per la struttura, ma un unico codice che comprende entrambi.

Differently to other models, Flexa S Maxi does not have a lampshade code and a code for the structure, but a unique code that covers both.

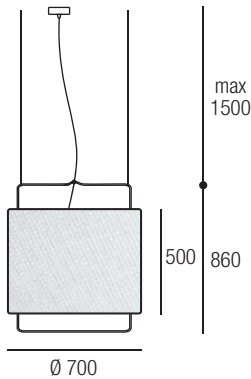

LED FLEXA S MAXI

Codice *Code*
500402/LED S+L Euro **525,53**

Materiali *Body*



Cromo (CR) + Bianco (WH)
Chrome (CR) + White (WH)

Peso *Weight*
9 Kg

Fonti luminose *Light source*



>30.000 h.



16W GLOBO LED E27 220÷240 3000K lens 300°

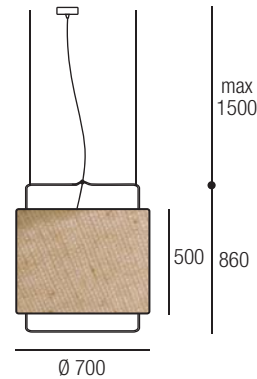

LED FLEXA S MAXI

Codice *Code*
500400/LED S+L Euro **525,53**

Materiali *Body*



Cromo (CR) + Écru (NT)
Chrome (CR) + Écru (NT)

Peso *Weight*
9 Kg

Fonti luminose *Light source*



>30.000 h.



16W GLOBO LED E27 220÷240 3000K lens 300°



V

complete di
paralume
with shade

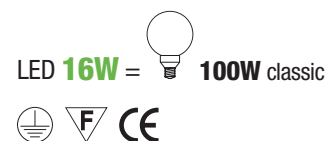
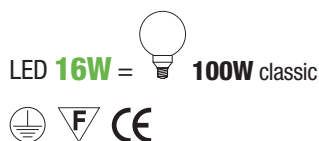
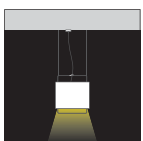

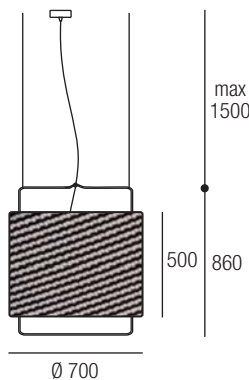
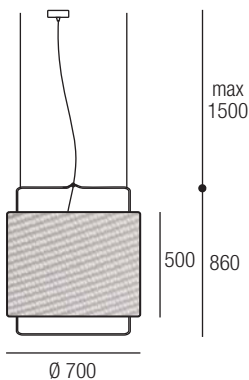
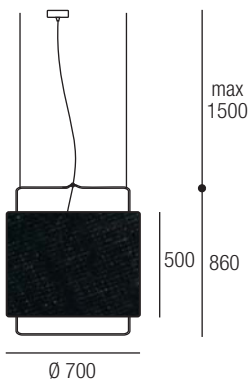

LED FLEXA S MAXI

Codice *Code*
500401/LED S+L Euro **525,53**

Materiali *Body*



Cromo (CR) + Nero (BK)
Chrome (CR) + Black (BK)

Peso *Weight*
9 Kg

Fonti luminose *Light source*



>30.000 h.



16W GLOBO LED E27 220÷240 3000K lens 300°

LED FLEXA S MAXI

Codice *Code*
500440/LED S+L Euro **491,40**

Materiali *Body*



Cromo (CR)+Bianco Melange (WH/MP)
Chrome (CR)+White Melange (WH/MP)

Peso *Weight*
9 Kg

Fonti luminose *Light source*



>30.000 h.



16W GLOBO LED E27 220÷240 3000K lens 300°

LED FLEXA S MAXI

Codice *Code*
500441/LED S+L Euro **491,40**

Materiali *Body*



Cromo (CR)+Nero Melange (BK/MP)
Chrome (CR)+Black Melange (BK/MP)

Peso *Weight*
9 Kg

Fonti luminose *Light source*



>30.000 h.



16W GLOBO LED E27 220÷240 3000K lens 300°

LED **16W** = **100W** classic



LED **16W** = **100W** classic



LED **16W** = **100W** classic







Scelta abat-jour
Choice abat-jour

Pagine
Page **106 - 107**

Per ottenere una lampada completa alla struttura va abbinato un codice di finitura del paralume. Questa lampada è dotata di varialuce Relco.

*To obtain a complete lamp, a lampshade finishing code must be coupled with the structure.
This lamp has a Relco dimmer.*

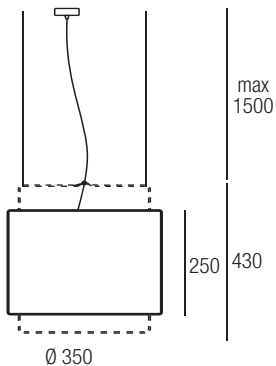

LED FLEXA S MINI

Codice Code Euro
500804/LED S+L 131,25

Materiali Body



Cromo (CR)
Chrome (CR)

Peso Weight
2,6 Kg

Fonti luminose Light source



>30.000 h.



8W LED E27 220÷240 3000K lens 300°



Coordinati | Coordinated

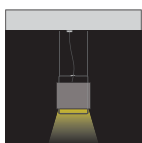

LED **8W** = **60W** classic



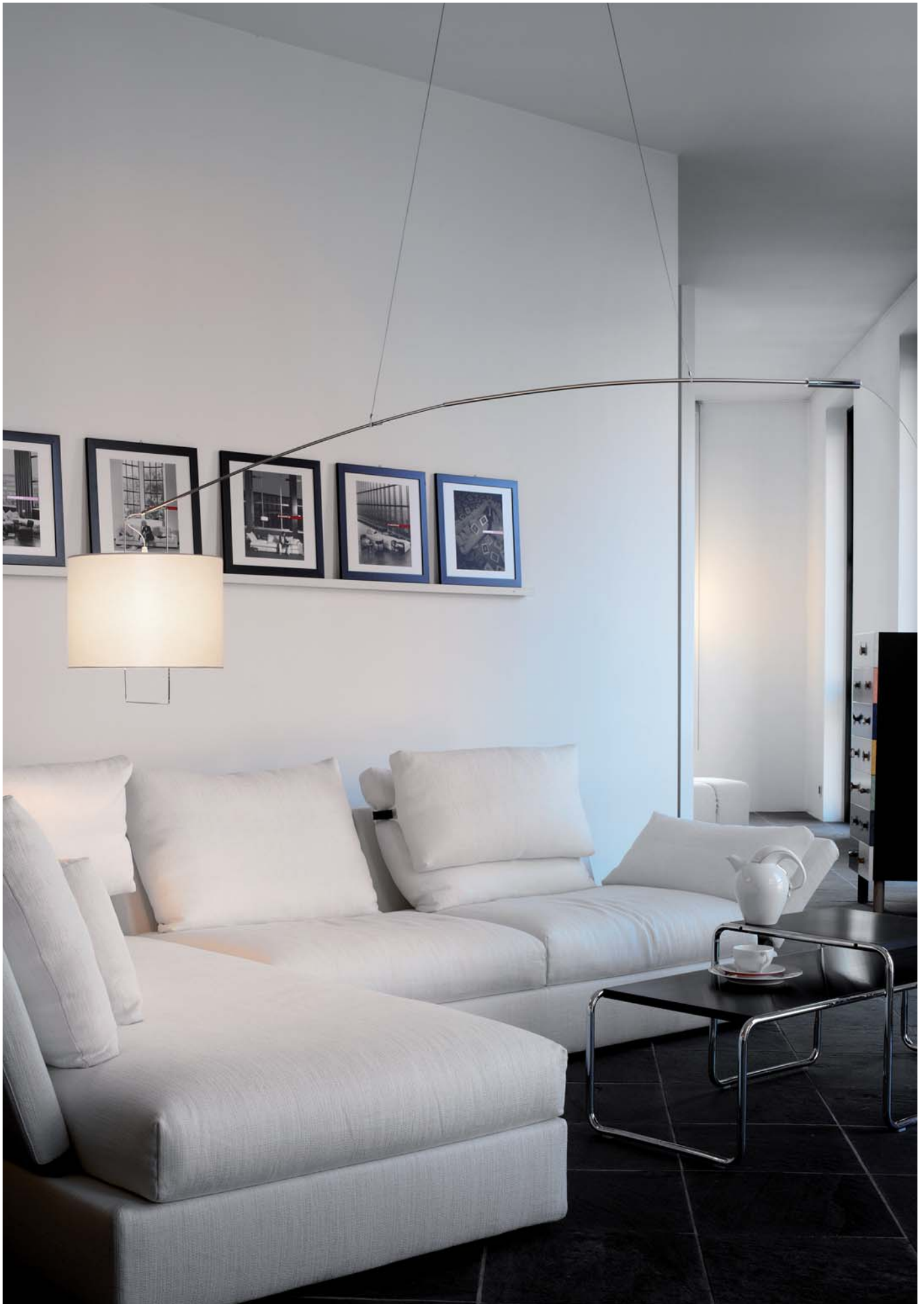



Scelta abat-jour
Choice abat-jour

Pagine
Page **106 - 107**

Per ottenere una lampada completa alla struttura va abbinato un codice di finitura del paralume. Questa lampada è dotata di varialuce Relco.

To obtain a complete lamp, a lampshade finishing code must be coupled with the structure. This lamp has a Relco dimmer.

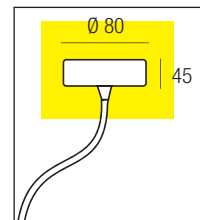
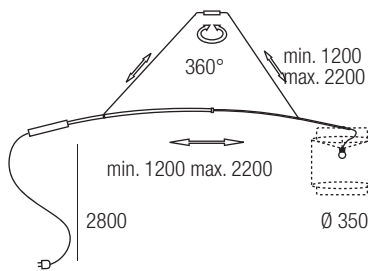
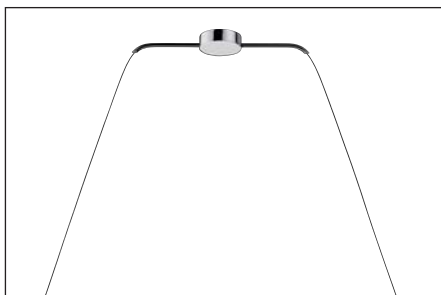
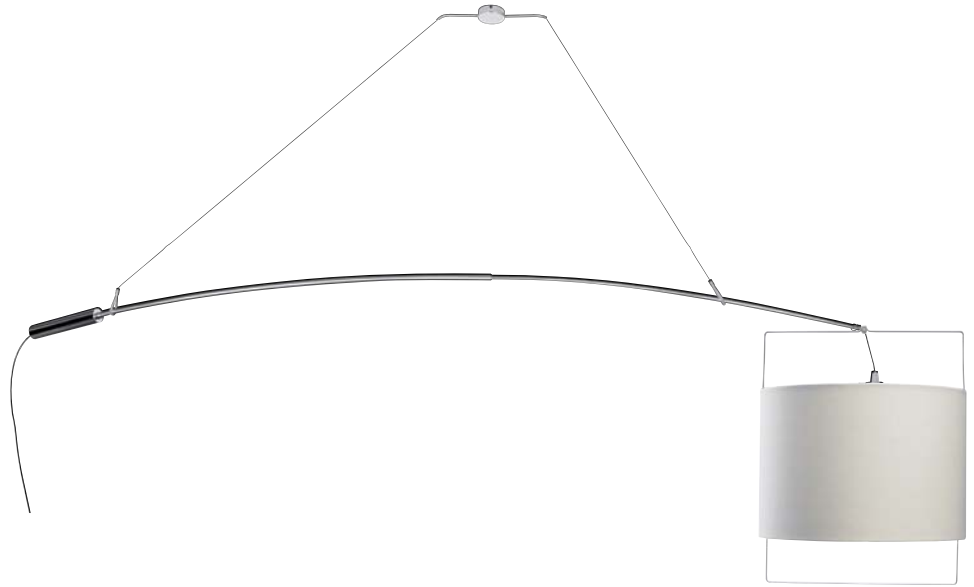

ACCESSORIO ACCESSORY

LED FLEXA S

Codice Code Euro
500004/LED S+L 240,24

Materiali Body



Cromo (CR)
Chrome (CR)

Peso Weight
2,15 Kg

Fonti luminose Light source



>30.000 h.



8W LED E27 220÷240 3000K lens 300°

FLEXA CEILING ROSE

Codice Code Euro
505119 17,75

Materiali Body



Nichel (NK)
Nickel (NK)

Peso Weight
0,2 Kg

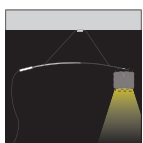

LED **8W** = **60W** classic







Scelta abat-jour
Choice abat-jour

Pagine
Page **106 - 107**

Per ottenere una lampada completa alla struttura va abbinato un codice di finitura del paralume. Questa lampada è dotata di varialuce Relco.

To obtain a complete lamp, a lampshade finishing code must be coupled with the structure. This lamp has a Relco dimmer.

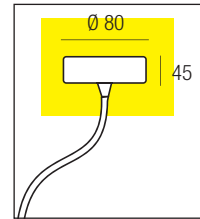
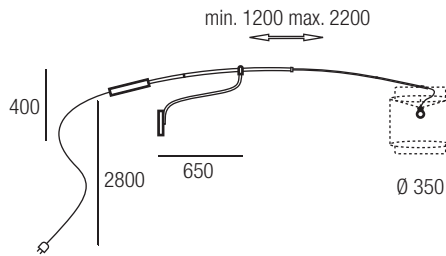
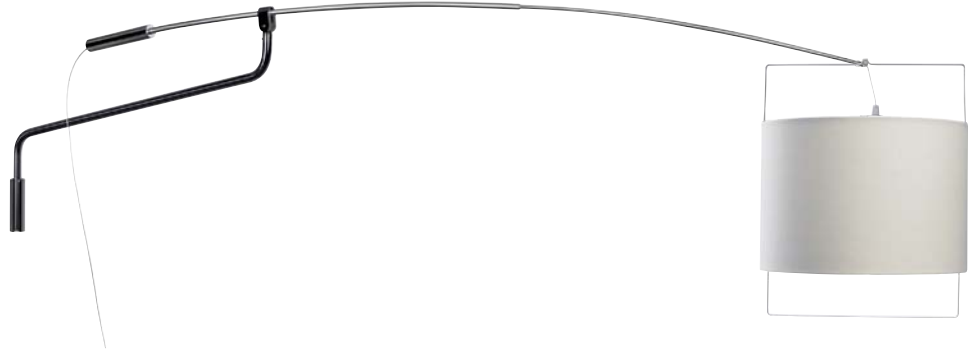

ACCESSORIO ACCESSORY

LED FLEXA W

Codice Code Euro
500204/LED S+L 328,97

Materiali Body



Cromo (CR)
Chrome (CR)

Peso Weight
4,4 Kg

Fonti luminose Light source



>30.000 h.



8W LED E27 220÷240 3000K lens 300°

FLEXA CEILING ROSE

Codice Code Euro
505119 17,75

Materiali Body



Nichel (NK)
Nickel (NK)

Peso Weight
0,2 Kg

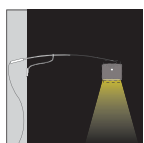

LED **8W** = **60W** classic



850°







Scelta abat-jour
Choice abat-jour

Pagine
Page **106 - 107**

Per ottenere una lampada completa alla struttura va abbinato un codice di finitura del paralume. Questa lampada è dotata di varialuce Relco.

*To obtain a complete lamp, a lampshade finishing code must be coupled with the structure.
This lamp has a Relco dimmer.*



LED FLEXA F

Codice *Code*
500600/LED S+L Euro **420,42**

Materiali *Body*

Cromo (CR)
Chrome (CR)

Peso *Weight*
16,3 Kg

Fonti luminose *Light source*

 **>30.000 h.**

CLASSE ENERGETICA
ENERGY CLASS
ENERGIEFFIZIENZKLASSE **A**

8W LED E27 220÷240 3000K lens 300°

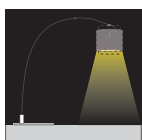

LED **8W** =  **60W** classic







Scelta abat-jour
Choice abat-jour

Pagine
Page **106 - 107**

Per ottenere una lampada completa alla struttura va abbinato un codice di finitura del paralume. Questa lampada è dotata di varialuce Relco.

To obtain a complete lamp, a lampshade finishing code must be coupled with the structure. This lamp has a Relco dimmer.

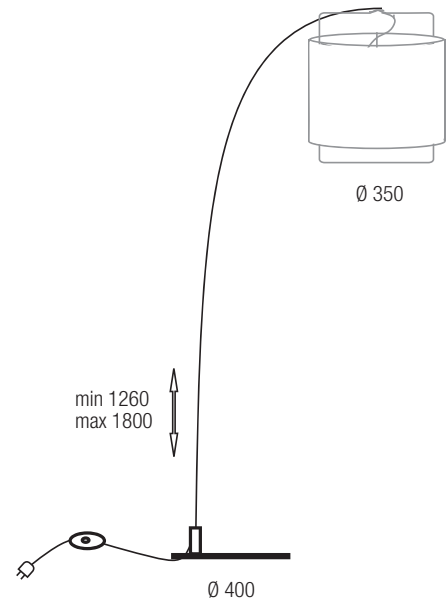

LED FLEXA FF

Codice	Code	Euro
500719	S+L	366,98

Materiali *Body*

Cromo (CR)
Chrome (CR)

Peso *Weight*
8,80 Kg

Fonti luminose *Light source*

 **>30.000 h.**



6W LED E27 220÷240 3000K lens 300°

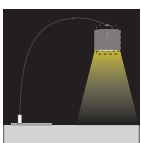

LED **6W** =  **40W** classic



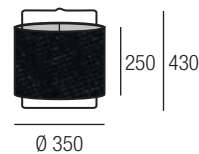
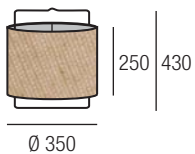
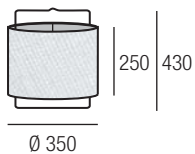

FLEXA ABAT-JOUR

Codice	Code	Euro
505002	S	152,88

Per codice For code
500804 - 500004 - 500204 - 500600

Materiali Body



Bianco (WH)
 White (WH)

Peso Weight
2,15 Kg



FLEXA ABAT-JOUR

Codice	Code	Euro
505000	S	152,88

Per codice For code
500804 - 500004 - 500204 - 500600

Materiali Body



Écru (NT)
 Écru (NT)

Peso Weight
2,15 Kg



FLEXA ABAT-JOUR

Codice	Code	Euro
505001	S	152,88

Per codice For code
500804 - 500004 - 500204 - 500600

Materiali Body



Nero (BK)
 Black (BK)

Peso Weight
2,15 Kg



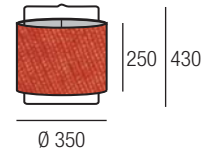
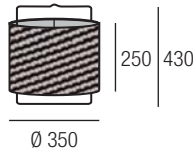
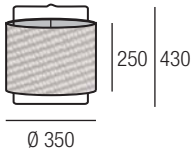

FLEXA ABAT-JOUR

Codice	Code	Euro
505040	S	146,06

Per codice For code
500804 - 500004 - 500204 - 500600

Materiali Body



Bianco Melange (WH/MP)
White Melange (WH/MP)

Peso Weight
2,15 Kg



FLEXA ABAT-JOUR

Codice	Code	Euro
505041	S	146,06

Per codice For code
500804 - 500004 - 500204 - 500600

Materiali Body



Nero Melange (BK/MP)
Black Melange (BK/MP)

Peso Weight
2,15 Kg



FLEXA ABAT-JOUR

Codice	Code	Euro
505003	S	152,88

Per codice For code
500804 - 500004 - 500204 - 500600

Materiali Body



Rosso (RD)
Red (RD)

Peso Weight
2,15 Kg







LED FLEXA TAVOLO

Codice *Code* Euro
505202 S+L 388,14

Materiali *Body*



Cromo (CR) + Bianco (WH)
 Chrome (CR) + White (WH)

Peso *Weight*
3,40 Kg

Fonti luminose *Light source*



>30.000 h.



4W LED E27 220÷240 3000K lens 300°



LED FLEXA TAVOLO

Codice *Code* Euro
505201 S+L 388,14

Materiali *Body*



Cromo (CR) + Nero (BK)
 Chrome (CR) + Black (BK)

Peso *Weight*
3,40 Kg

Fonti luminose *Light source*



>30.000 h.



4W LED E27 220÷240 3000K lens 300°



LED FLEXA TAVOLO

Codice *Code* Euro
505240 S+L 388,14

Materiali *Body*



Cromo (CR) + Bianco Melange (WH/MP)
 Chrome (CR) + White Melange (WH/MP)

Peso *Weight*
3,40 Kg

Fonti luminose *Light source*



>30.000 h.





4W LED E27 220÷240 3000K lens 300°

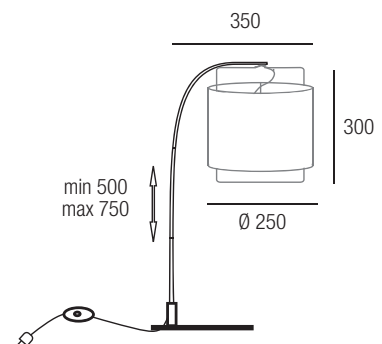

V

complete di
 paralume
 with shade



LED **4W** =  **30W** classic



lighting technologies





LED NOTA

Adrian Peach

Le LED NOTA sono lampade da interni, semplici e curate nei particolari, dal design minimalista ed emissione luminosa diretta ed efficace. Posizionabili a soffitto o a parete offrono la possibilità di orientare ogni singola ottica tramite il sistema a snodo di $\pm 90^\circ$.

Adatte per musei, negozi, esposizioni sono molto apprezzate anche all'interno di abitazioni moderne.

Caratteristiche tecniche:

Corpo in metallo.

Diffusori in policarbonato satinato.

Alimentatore elettronico Relco incorporato.

Lampada LED Leuci a corredo.

The style of NOTA LED lamps for interiors is simple with an attention to detail, featuring a minimalist design, with direct and efficient light emission. They can be ceiling or wall-mounted, providing the possibility of adjusting the direction of every single optic through a $\pm 90^\circ$ joint system.

They are suitable for museums, shops, exhibitions, and also highly appreciated in modern dwellings.

Technical features:

Metal body.

Satin-finish polycarbonate shades.

Built-in Relco electronic power supply unit.

Leuci LED lamp included.



Orientamento
Orientation



Blocco a stringere con astina
Locking mechanism

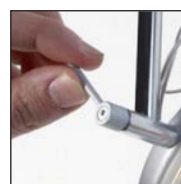

Coordinati | Coordinated



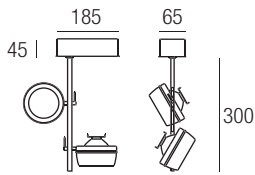

LED NOTA C2

Codice	Code	Euro
363324	CELL	505,05
363224	CELL	505,05

Materiali *Body*



Argento/Cromo (AG/CR)
Silver/Chrome (AG/CR)

Peso *Weight*

1,25 Kg

Fonti luminose *Light source*



>30.000 h.

363324

2x15W POWERLED 700mA 6000K lens 30°



>30.000 h.

363224

2x15W POWERLED 700mA 3000K lens 30°

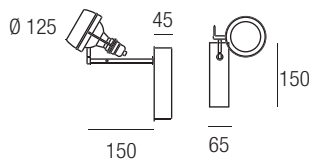

LED NOTA W1

Codice	Code	Euro
360124	CELL	327,60
360024	CELL	327,60

Materiali *Body*



Argento/Cromo (AG/CR)
Silver/Chrome (AG/CR)

Peso *Weight*

1,2 Kg

Fonti luminose *Light source*



>30.000 h.

360124

27W POWERLED 700mA 6000K lens 30°



>30.000 h.

360024

27W POWERLED 700mA 3000K lens 30°

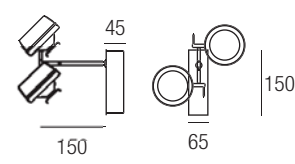

LED NOTA W2

Codice	Code	Euro
360624	CELL	466,83
360524	CELL	466,83

Materiali *Body*



Argento/Cromo (AG/CR)
Silver/Chrome (AG/CR)

Peso *Weight*

1,25 Kg

Fonti luminose *Light source*



>30.000 h.

360624

2x15W POWERLED 700mA 6000K lens 30°



>30.000 h.

360524

2x15W POWERLED 700mA 3000K lens 30°

LED **15W** = **75W** HALO



LED **27W** = **100W** HALO



LED **15W** = **75W** HALO





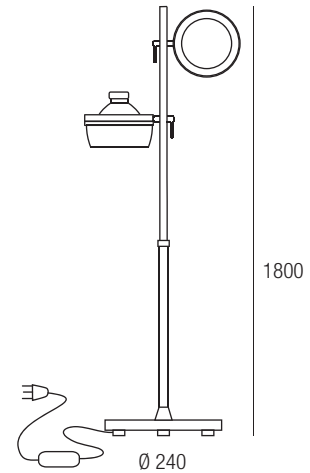

LED NOTA F2

Codice	Code	Euro
363524	CELL	768,50
363424	CELL	768,50

Materiali Body



Argento/Cromo (AG/CR)
Silver/Chrome (AG/CR)

Peso Weight

10,25 Kg

Fonti luminose Light source



>30.000 h.

363524

2x15W POWERLED 700mA 6000K lens 30°



>30.000 h.

363424

2x15W POWERLED 700mA 3000K lens 30°

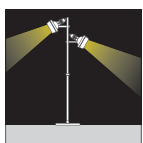

LED **15W** =  **75W HALO**







LED TRIBECA

Andrea Castelli & Fabio Rezzonico

Le LED TRIBECA sono lampade moderne, in vetro e acciaio, gradevoli e dal design piacevole, benché semplice e pulito. Disponibili in varie versioni da plafone (Tribeca C), parete (Tribeca W), sospensione e in vari modelli (Tribeca S). Sono lampade adatte ad illuminare corridoi, vani scala, ambienti di piccole dimensioni, ma anche tavoli da pranzo in abitazioni, ristoranti o banconi bar.

La versione a plafone "C" è disponibile in 3 modelli. La versione a sospensione "S", con cavo di 1,5m, è disponibile in 5 modelli.

È disponibile l'accessorio Tribeca DEC ceiling rose composto da rosone e cavo di 3m, utile ove si renda necessario decentrare l'apparecchio rispetto al punto luce.

Caratteristiche tecniche:

Struttura in metallo con finitura nichel satinato o cromo lucido.

Vetro stampato con lavorazioni artigianali.

Nota:

Lievi imperfezioni superficiali o cambi di spessore sono caratteristiche tipiche di lavorazioni artigianali e vetri di qualità. Pertanto non sono da considerarsi difetti di fabbricazione ma pregi di lavorazioni fatte a mano.

Alimentatore elettronico Relco incorporato.

Lampada LED leuci a corredo.

TRIBECA LED lamps are modern, made with glass and steel, pleasing to the eye and offering an appealing design, simple and streamlined. Available in various ceiling (Tribeca C), wall (Tribeca W), and suspension versions, and various models (Tribeca S).

These lamps are suitable for corridors, stair-wells, small rooms, as well as home and restaurant dining tables or bar counters.

The "C" ceiling version comes in three models.

The "S" suspension version, with a 1.5 m cable, comes in 5 models.

The Tribeca DEC ceiling rose accessory is available, comprised of a ceiling rose and 3 m cable which is useful to adjust the position of the light fixture to reach the required lighting point.

Technical features:

Metal structure with satin-finish nickel or glossy chrome finish.

Moulded glass with craftsman processing.

Note:

Slight imperfections on the surface or differences in thickness are typical signs of craftsmanship and quality glass. Accordingly, these are not considered factory defects, rather the distinguishing marks of hand-processing.

Built-in Relco electronic power supply unit.

Leuci LED lamp included.



Coordinati | Coordinated



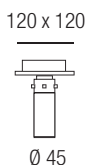



LED TRIBECA C1

Codice	Code	Euro
140004/LED	CELL (CR)	176,09
140019/LED	CELL (NK)	177,45

Materiali *Body*

 **140004/LED**
Cromo (CR)
Chrome (CR)

 **140019/LED**
Nichel (NK)
Nickel (NK)

Peso *Weight*
0,95 Kg

Fonti luminose *Light source*

 **>30.000 h.**
4W LED E14 220÷240V 3000K lens 40°

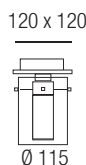

LED TRIBECA C2

Codice	Code	Euro
141704/LED	CELL (CR)	211,58
141719/LED	CELL (NK)	214,31

Materiali *Body*

 **141704/LED**
Cromo (CR)
Chrome (CR)

 **141719/LED**
Nichel (NK)
Nickel (NK)

Peso *Weight*
1,5 Kg

Fonti luminose *Light source*

 **>30.000 h.**
4W LED E14 220÷240V 3000K lens 40°

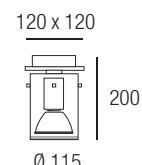

LED TRIBECA C4

Codice	Code	Euro
141904/LED	S+L (CR)	260,78
141919/LED	S+L (NK)	255,24

Materiali *Body*

 **141904/LED**
Cromo (CR)
Chrome (CR)



 **141919/LED**
Nichel (NK)
Nickel (NK)



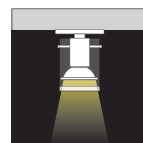

Peso *Weight*
1,8 Kg





Fonti luminose *Light source*

 **>30.000 h.**
12W LED E27 220÷240V 3000K lens 25°



LED **4W** =  **30W** classic
  

LED **4W** =  **30W** classic
  

LED **12W** =  **75W** classic
  



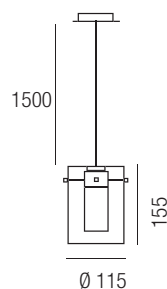
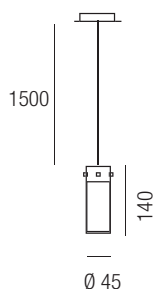



LED TRIBECA S1/1

LED TRIBECA S1/1

Codice	Code	Euro
141004/LED	CELL (CR)	193,83
141019/LED	CELL (NK)	192,47

Materiali *Body*

 **141004/LED**
Cromo (CR)
Chrome (CR)

 **141019/LED**
Nichel (NK)
Nickel (NK)

Peso *Weight*
1,05 Kg

Fonti luminose *Light source*

 **>30.000 h.**

4W LED E14 220÷240V 3000K lens 40°



LED TRIBECA S1/2

LED TRIBECA S1/2

Codice	Code	Euro
141204/LED	CELL (CR)	279,83
141219/LED	CELL (NK)	237,51

Materiali *Body*

 **141204/LED**
Cromo (CR)
Chrome (CR)

 **141219/LED**
Nichel (NK)
Nickel (NK)

Peso *Weight*
1,7 Kg

Fonti luminose *Light source*

 **>30.000 h.**

4W LED E14 220÷240V 3000K lens 40°

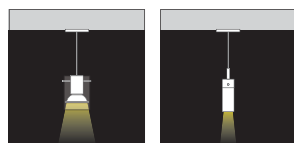

LED **4W** =  **30W** classic



LED **4W** =  **30W** classic







LED TRIBECA S1

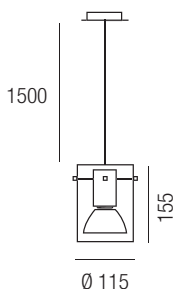

LED TRIBECA S1

Codice	Code	Euro
140804/LED	S+L (CR)	240,24
140819/LED	S+L (NK)	232,05

Materiali *Body*

 **140804/LED**
Cromo (CR)
Chrome (CR)

 **140819/LED**
Nichel (NK)
Nickel (NK)

Peso *Weight*
1,85 Kg

Fonti luminose *Light source*

 **>30.000 h.**

12W LED E27 220÷240V 3000K lens 25°

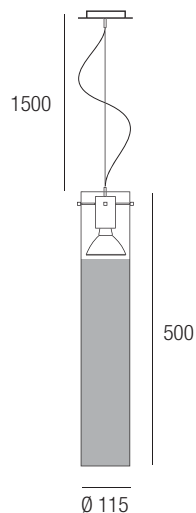

LED TRIBECA S1 LONG

Codice	Code	Euro
142004/LED	S+L (CR)	342,62
142019/LED	S+L (NK)	333,06

Materiali *Body*

 **142004/LED**
Cromo (CR)
Chrome (CR)

 **142019/LED**
Nichel (NK)
Nickel (NK)

Peso *Weight*
2,6 Kg

Fonti luminose *Light source*

 **>30.000 h.**

12W LED E27 220÷240V 3000K lens 25°



LED TRIBECA S1 LONG



LED **12W** =  **75W** classic



LED **12W** =  **75W** classic







Sospensione | Suspension

LED TRIBECA S CUBE

Andrea Castelli & Fabio Rezzonico



LED TRIBECA S1 CUBE - SPENTA/OFF



LED TRIBECA S1 CUBE - ACCESA/ON

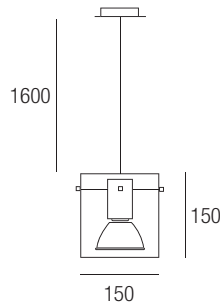
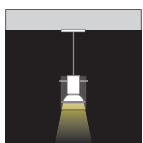

LED TRIBECA S1 CUBE

Codice	Code	Euro
142104/LED	S+L (CR)	245,84
142119/LED	S+L (NK)	240,27

Materiali *Body*

 **142104/LED**
Cromo (CR)
Chrome (CR)

 **142119/LED**
Nichel (NK)
Nickel (NK)

Peso *Weight*
1,6 Kg

Fonti luminose *Light source*

 **>30.000 h.**
12W LED E27 220÷240V 3000K lens 25°

LED **12W** =  **75W** classic



Accessorio per Tribeca Accessories for Tribeca

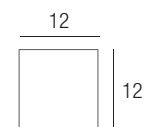

ACCESSORIO ACCESSORY

TRIBECA DEC CEILING ROSE

Codice	Code	Euro
145004	(CR)	75,08
145019	(NK)	76,44

Materiali *Body*

 **145004**
Cromo (CR)
Chrome (CR)

 **145019**
Nichel (NK)
Nickel (NK)

Peso *Weight*
0,5 Kg

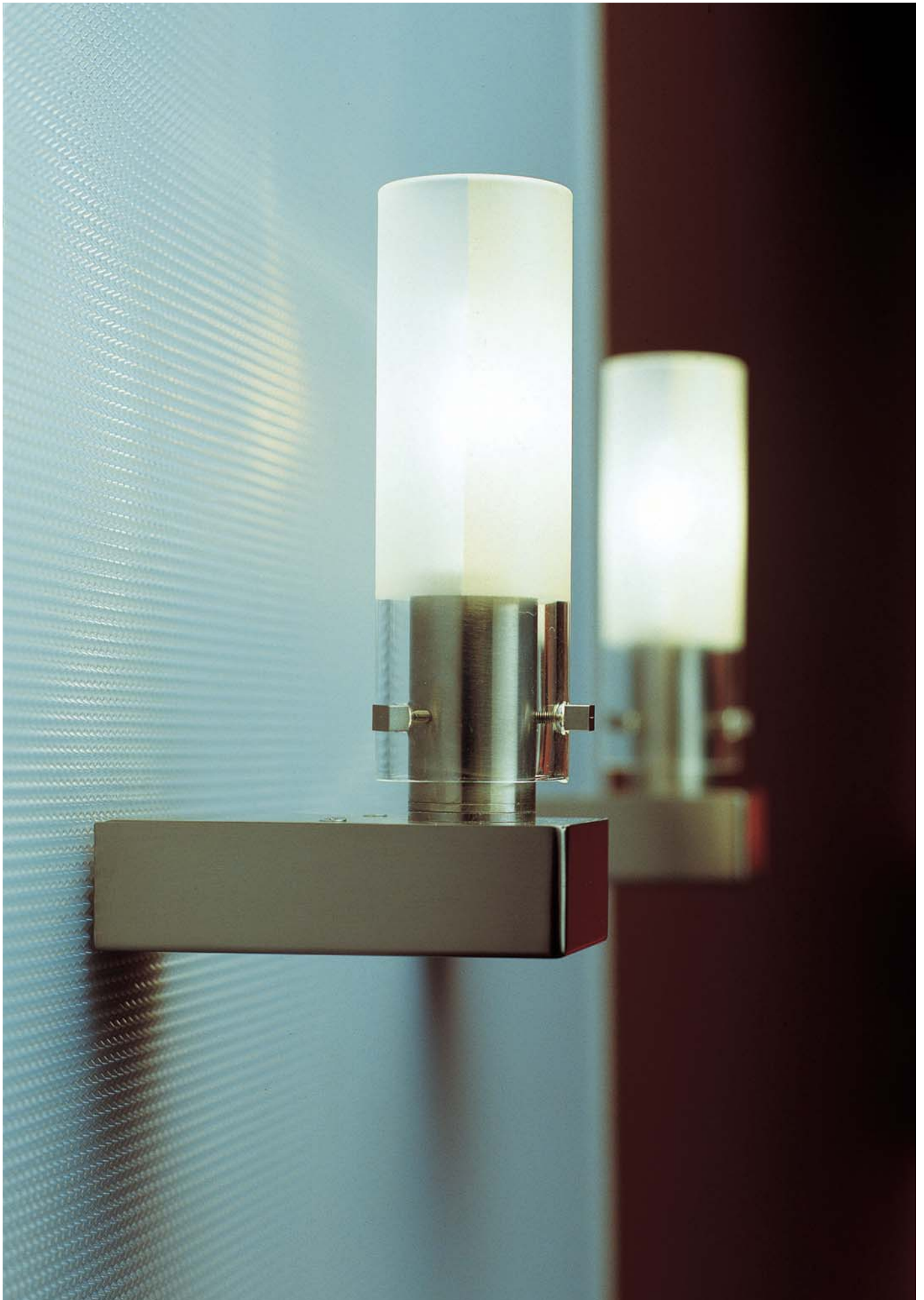



LED TRIBECA W

Andrea Castelli & Fabio Rezzonico

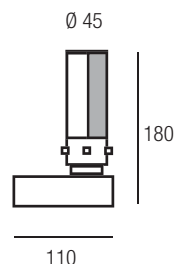

LED TRIBECA W

Codice	Code	Euro
140704/LED	CELL (CR)	155,61
140719/LED	CELL (NK)	166,53

Materiali Body

 **140704/LED**
Cromo (CR)
Chrome (CR)

 **140719/LED**
Nichel (NK)
Nickel (NK)

Peso Weight
0,85 Kg

Fonti luminose Light source



>30.000 h.

4W LED E14 220÷240V 3000K lens 40°



LED **4W** =  **30W** classic







PARETE PLAFONE PIANTANA INCASSO



CEILING WALL FLOOR
RECESSED

da
from

128

a
to

213

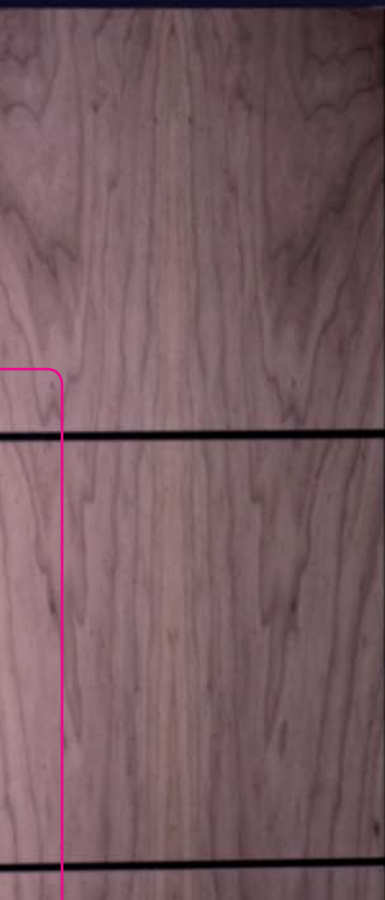

LED ASTER è una lampada versatile, pratica, leggera, poco ingombrante ed efficace. E' molto resistente agli shock termici e quindi può essere installata a soffitto o a parete anche all'esterno (IP65). Con LED ASTER illumini i tuoi spazi con una calda luce diffusa ed uniforme. Disponibile nei colori: bianco, antracite, alluminio spazzolato.

Caratteristiche tecniche:

Corpo in alluminio pressofuso.

Verniciatura di tipo poliestere eseguita a polvere.

Diffusore in vetro temperato satinato in modo da non rendere visibile l'interno della lampada.

Alimentatore elettronico Relco incluso.

ASTER LED is a versatile, practical, lightweight, compact and efficient lamp. It is very resistant to thermal shock and can therefore be ceiling or wall-mounted, including outdoors (IP65). With ASTER LED you can light up your spaces with a warm and uniform light. Available in these colours: white, anthracite brushed aluminium.

Technical features:

Die-cast aluminium body.

Painting: powder polyester coating.

Shade made with satin-finish tempered glass, so as to ensconce the inside of the lamp.

Electronic Relco power supply unit included.





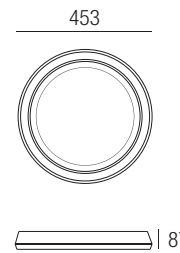
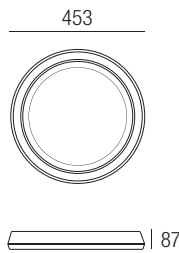
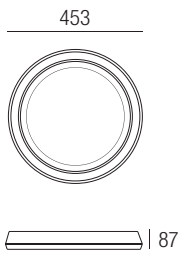

ASTER - LED ASTER

Codice	Code	Euro
32351	CELL	207,48
32351/LED	CELL	258,70

Materiali *Body*



Bianco (WH)
White (WH)

Peso *Weight*
2,4 Kg

Fonti luminose *Light source*



40+22W 2GX13 230V 3000K



>30.000 h.

30W LED 230V 4000K

ASTER - LED ASTER

Codice	Code	Euro
32353	CELL	207,48
32353/LED	CELL	258,70

Materiali *Body*



Antracite (AT)
Anthracite (AT)

Peso *Weight*
2,4 Kg

Fonti luminose *Light source*



40+22W 2GX13 230V 3000K



>30.000 h.

30W LED 230V 4000K

ASTER - LED ASTER

Codice	Code	Euro
32355	CELL	207,48
32355/LED	CELL	258,70

Materiali *Body*



Alluminio spazzolato (AA)
Brushed Aluminium (AA)

Peso *Weight*
2,4 Kg

Fonti luminose *Light source*



40+22W 2GX13 230V 3000K



>30.000 h.

30W LED 230V 4000K



LED **30W** =  **40W** Fluo



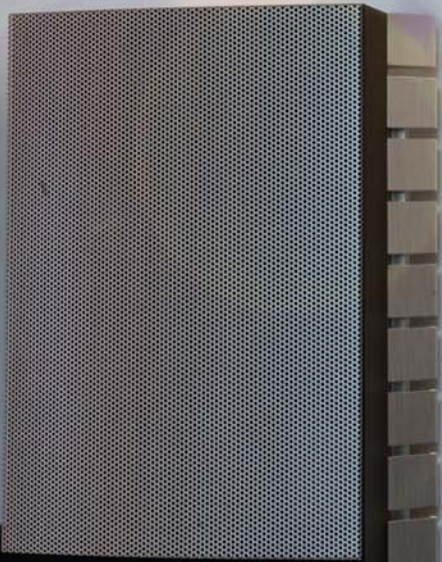

LED AXOLUTE W MINI, è moderno e tecnologico faretto da parete per interni, orientabile a proprio piacimento ideale soprattutto per creare gradevoli effetti luce d'effetto e d'accento. Molto adatto per musei, negozi, esposizioni vista l'assenza di emissioni di raggi UV, la ridotta emissione di calore, la lunga durata e il bassissimo consumo energetico. Viste le caratteristiche può anche essere inserito in qualsiasi contesto abitativo e lavorativo.

Caratteristiche di tecniche:

Corpo in lega di alluminio verniciata a polvere.
 Diffusore con lente acrilica prismaticata.
 Sorgente Power LED bianco 3000K o 6000K.
 Alimentatore elettronico Relco incorporato.
 Lampada LED leuci a corredo.

AXOLUTE W MINI LED is a modern and technological wall-mounted, indoor spotlight that is direction-adjustable as needed, especially ideal for creating appealing dramatic and accent lighting. Highly suitable for museums, shops, and displays as it does not produce UV rays, it offers very low heat emissions, long lifespan and very low energy consumption. Thanks to these characteristics, it can also be used in any home or work context.

Technical features:

*Powder-coated aluminium alloy body.
 Shade with prismatic acrylic lens.
 3,000K or 6,000K white LED Power source.
 Built-in Relco electronic power supply unit.
 Leuci LED lamp included.*

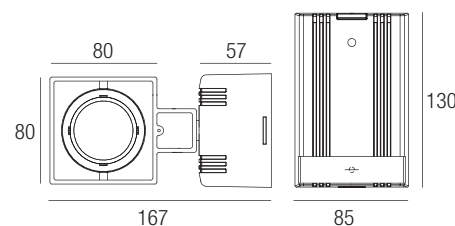

LED AXOLUTE W MINI

Codice	Code	Euro
32388	CELL	106,47
32384	CELL	106,47

Materiali *Body*



Alluminio (AA)
 Aluminium (AA)

Peso *Weight*

0,7 Kg

Fonti luminose *Light source*



>30.000 h.

32388

9W LED 700mA 220÷240 3000K lens 30°



>30.000 h.

32384

9W LED 700mA 220÷240 6000K lens 30°



LED **9W** =  **50W HALO**





BABY è un'originale lampada da parete, simpatica, dal design piacevole e creativo. E' anche pratica e confortevole in quanto può ruotare sull'asse verticale di 360° dando la possibilità di orientare la luce.

La sorgente di cui è fornita è per metà argentata e per metà trasparente, un particolare che la rende più elegante e di stile. Ideale nelle camere da letto come luce da comodino, si presta però anche ad altre ubicazioni a seconda del gusto personale.

Caratteristiche tecniche:

Struttura in filo d'acciaio cromato e particolari stampati a iniezione in policarbonato cristallo opaco.

Cavo (lunghezza 200 cm), interruttore e spina trasparenti.

A richiesta è disponibile l'accessorio per il collegamento elettrico con i cavi a muro (Baby electric box) e la lampada di ricambio (Baby bulb).

BABY is an original, fun wall lamp, with an appealing and creative design. It is also practical and comfortable, as it can turn on its vertical axis by 360°, making it possible to change the direction of the light.

The source it is fitted with is half silver-plated and half transparent, a detail that makes it even more elegant and stylish.

Although it is ideal for the bedroom as a bedside light, it is also suitable for other places depending on personal taste.

Technical features:

Chrome plated steel wire structure and injection moulded particulars in matt crystal polycarbonate.

Transparent cable (length 200 cm), switch and plug.

The accessory for the electrical connection with wall wires (Baby electric box) and the spare bulb (Baby bulb) are available on request.

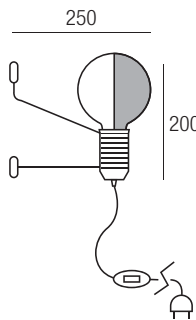

BABY
Codice Code Euro
150004 S+L 109,20

Materiali Body



Cromo (CR)
Chrome (CR)

Peso Weight
0,6 Kg

Fonti luminose Light source



60W E27 ø120mm 230V 2700K

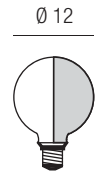

ACCESSORIO ACCESSORY

BABY BULB
Codice Code Euro
155000 L 16,38

Peso Weight
0,08 Kg

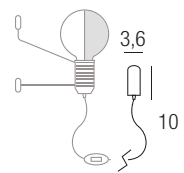

ACCESSORIO ACCESSORY

BABY ELECTRIC BOX
Codice Code Euro
155100 28,67

Materiali Body



Argento (AG)
Silver (AG)

Peso Weight
0,15 Kg

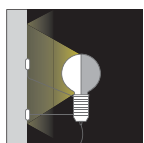

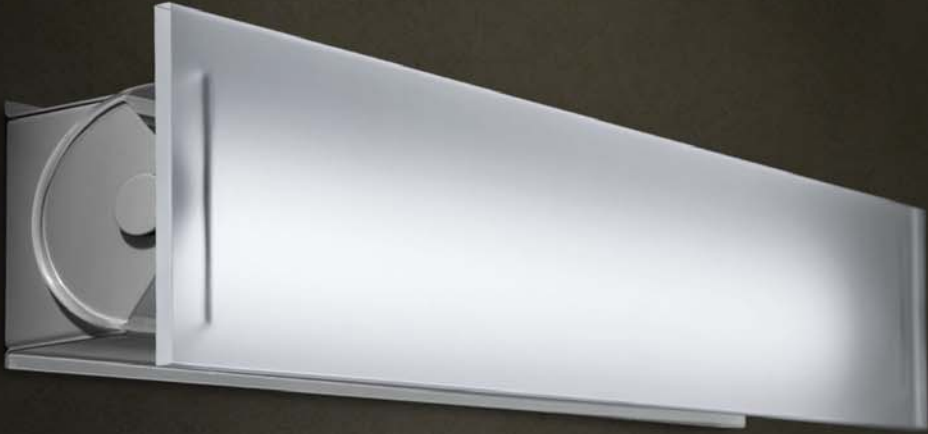

02 lab

LED BOX è una moderna lampada da parete dal design semplice ed essenziale, adatta a tutti gli spazi ove si desideri un'emissione luminosa dall'alto o dal basso regolabile sia per intensità che per apertura del flusso. La sua forma lineare e geometrica la rende ideale in tutti gli ambienti abitativi, negli uffici, nelle hall e negli ingressi a prescindere dallo stile architettonico degli spazi.

Con Led BOX illumini e risparmi grazie alla tecnologia led.

Disponibile in tre diverse lunghezze. 650 cm, 950 cm, 1250 cm. Disponibile nei colori verniciati bianco RAL 9010 e Silver

Caratteristiche tecniche:

Corpo in metallo verniciato.

Schermo in plexiglas smerigliato inclinabile

Sorgente LED di potenza a 4000K

Alimentazione: elettronica Relco inclusa

BOX LED is a modern wall lamp with a simple and basic design, suitable for any space where you want the light emission to be set up from above or below, with adjustable intensity and flow-opening. Its linear and geometric shape makes it ideal in any living environment, office, hall and entrance, regardless of the architectural style of the spaces.

With BOX Led you get lighting and savings, thanks to the led technology.

Available in three different lengths. 650 cm, 950 cm, 1,250 cm. Available with white RAL 9010 and Silver coating

Technical features:

Painted metal body.

Tilted, frosted plexiglas screen

4,000K power LED source

Power supply: electronic by Relco (included)



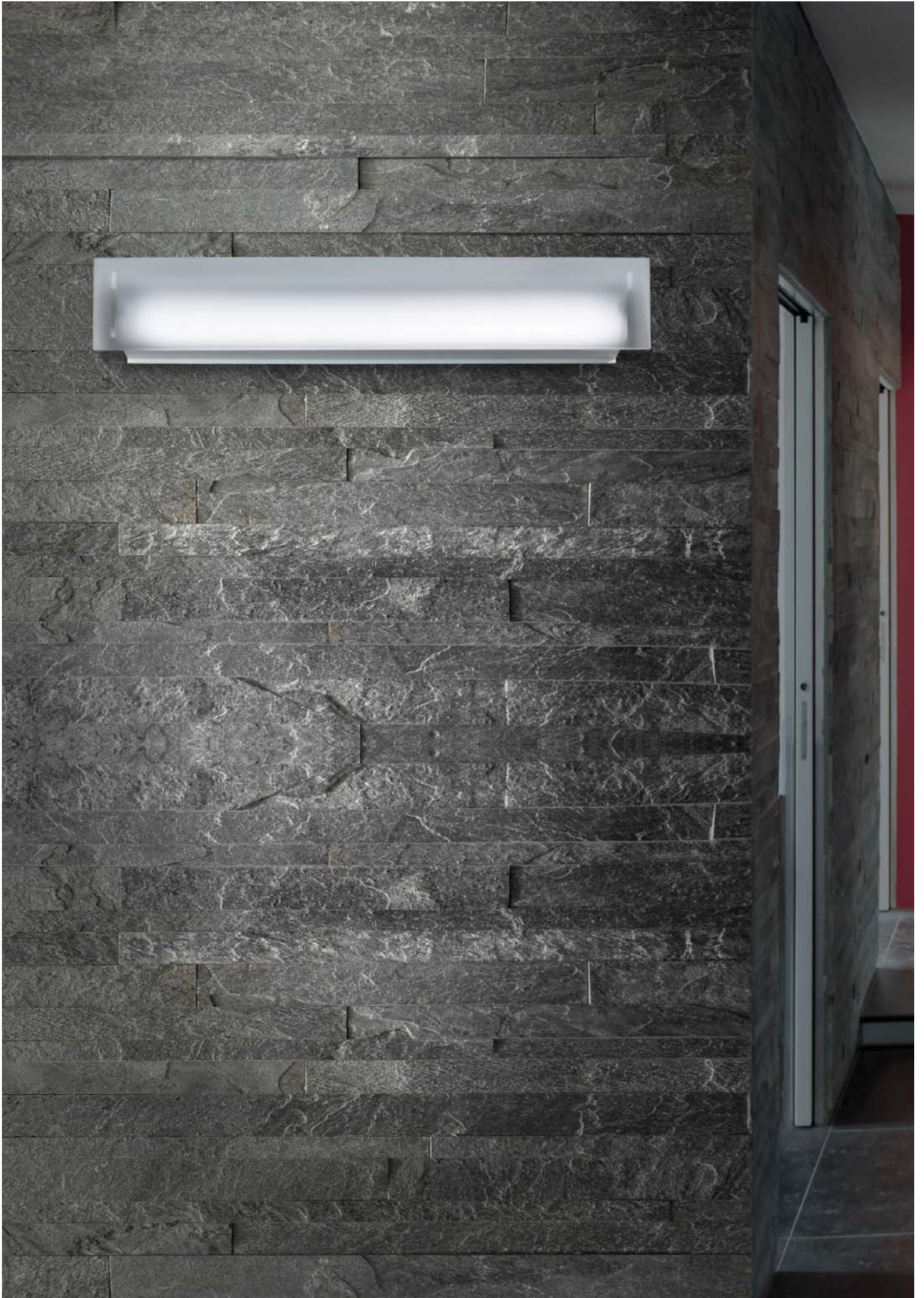

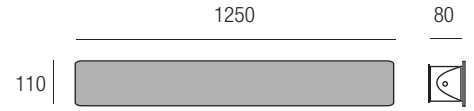
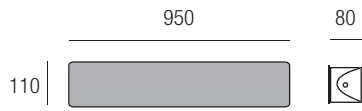
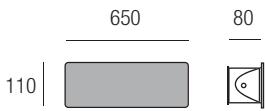

LED BOX 60

Codice	Code	Euro
510002/LED	CELL (WH)	242,97
510017/LED	CELL (AG)	274,37

Materiali *Body*

 **510002/LED**
Bianco (WH)
White (WH)

 **510017/LED**
Argento (AG)
Silver (AG)

Peso *Weight*
4,15 Kg

Fonti luminose *Light source*

 **>30.000 h.**
24W POWERLED 220÷240V 4000K lens 110°

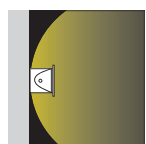

LED **24W** =  **50W** classic



LED BOX 90

Codice	Code	Euro
510102/LED	CELL (WH)	405,60
510117/LED	CELL (AG)	320,78

Materiali *Body*

 **510102/LED**
Bianco (WH)
White (WH)

 **510117/LED**
Argento (AG)
Silver (AG)

Peso *Weight*
5,9 Kg

Fonti luminose *Light source*

 **>30.000 h.**
36W POWERLED 220÷240V 4000K lens 110°

LED **36W** =  **100W** classic



LED BOX 120

Codice	Code	Euro
510202/LED	CELL (WH)	488,51
510217/LED	CELL (AG)	488,51

Materiali *Body*

 **510202/LED**
Bianco (WH)
White (WH)

 **510217/LED**
Argento (AG)
Silver (AG)

Peso *Weight*
7,05 Kg

Fonti luminose *Light source*

 **>30.000 h.**
48W POWERLED 220÷240V 4000K lens 110°

LED **48W** =  **200W** classic





LED DADO sono lampade per interni semplici e moderne, funzionali, che emettono un gradevole effetto di luce radente. Disponibili in tre misure e con diversi wattaggi così da soddisfare al meglio le esigenze personali. Il design minimale permette di inserirle in qualsiasi ambiente e con qualsiasi stile architettonico. Alcune lampade hanno una doppia emissione di luce sopra e sotto.

Caratteristiche tecniche:

- Corpo in alluminio estruso.
- Dado W 60 ha diffusori in vetro satinato.
- Dado Mini W Double ha una doppia emissione di luce.
- Dado Mini C e W ha una sola emissione di luce.
- Alimentatore elettronico Relco incorporati.
- Lampada LED leuci a corredo.

DADO LED are simple and modern, functional indoor lamps that provide an appealing grazing light effect. Available in three sizes and with different wattages, to fulfil personal requirements as best as possible. The minimal design makes it possible to use them in any setting and any architectural style. Some lamps have dual light output, above and below.

Technical features:

- Brushed aluminium body.
- Dado W 60 has satin-finish glass shades.
- Dado Mini W Double features dual light output.
- Dado Mini C and W only have one light emission source.
- Built-in Relco electronic power supply units.
- Leuci LED lamp included.



LED DADO W 60

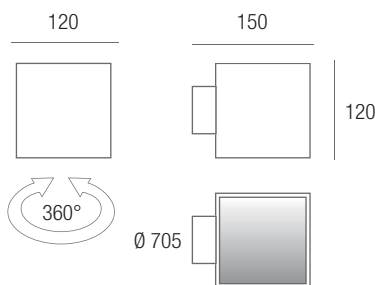

LED DADO W 60

Codice *Code*
210017/LED S+L Euro **154,25**

Materiali *Body*



Argento (AG)
 Silver (AG)

Peso *Weight*
1,3 Kg

Fonti luminose *Light source*



>30.000 h.

8W LED E27 220÷240V 3000K lens 25°

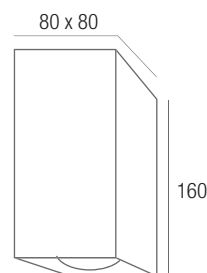

LED DADO MINI W DOUBLE

Codice *Code*
210417/LED S+L Euro **211,58**

Materiali *Body*



Argento (AG)
 Silver (AG)

Peso *Weight*
1,1 Kg

Fonti luminose *Light source*



>30.000 h.

2x6W LED GU10 220÷240V 3000K lens 25°

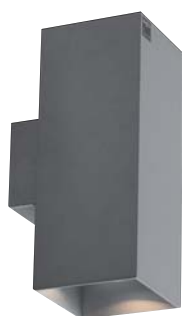

LED DADO MINI W DOUBLE



LED **8W** = **60W** classic



LED **6W** = **40W** HALO



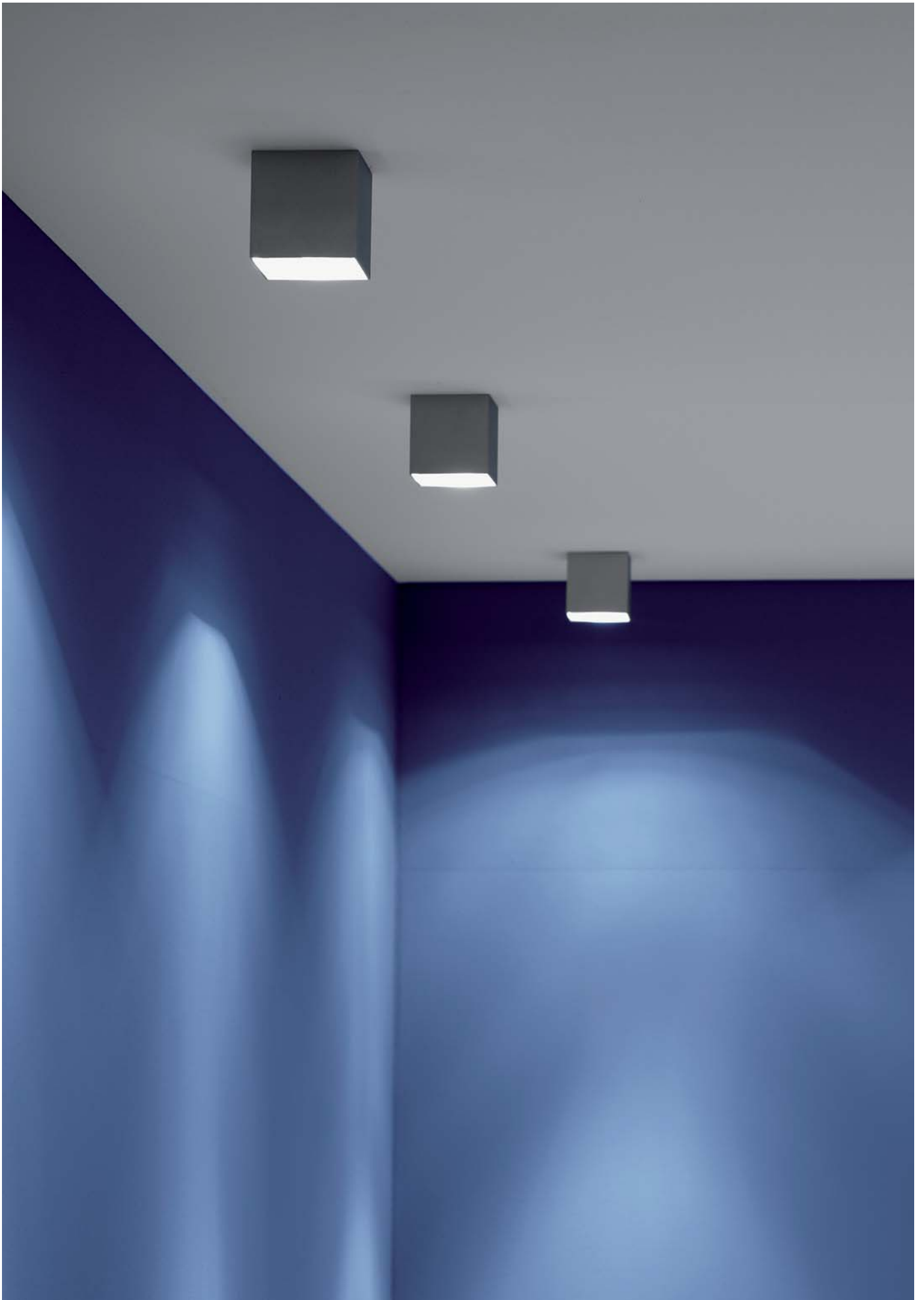

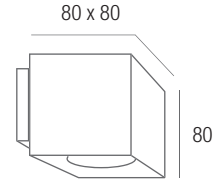
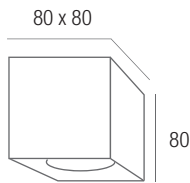

LED DADO MINI C

Codice *Code*
210217/LED S+L Euro **88,73**

Materiali *Body*



Argento (AG)
Silver (AG)

Peso *Weight*
0,4 Kg

Fonti luminose *Light source*



>30.000 h.

6W LED GU10 90÷240V 3000K lens 30°

LED DADO MINI W

Codice *Code*
210317/LED S+L Euro **114,66**

Materiali *Body*



Argento (AG)
Silver (AG)

Peso *Weight*
0,6 Kg

Fonti luminose *Light source*



>30.000 h.

6W LED GU10 90÷240V 3000K lens 30°



LED **6W** = **40W HALO**

LED **6W** = **40W HALO**





EGOO sono lampade originali, creative, molto particolari e personalizzabili nella forma. Con LED EGOO dai sfogo al tuo gusto personale: la struttura in alluminio è flessibile, allungabile e modellabile a piacere. Adatta a qualsiasi spazio e a qualsiasi stile, disponibile per interni ma anche per esterni per illuminare con un tocco in più giardini e aiuole (Egooo Outdoor IP44). L'installazione può essere d'appoggio oppure fissa a soffitto (Egooo C) o a parete (Egooo W).

Caratteristiche tecniche:

Corpo in alluminio

Lampada spot Leuci E27 (è possibile richiedere anche una lampada LED della serie Life Energy da sostituire a quella in dotazione).

EGOO are original, creative, very unique lamps with a customisable shape. With EGOO LED you can unleash your personal taste: the aluminium structure is flexible, extendible and can be made into any shape you like. Suitable for any space and any style, it is available for interiors and exteriors, to enhance garden and flowerbed lighting (Egooo Outdoor IP44). It can be installed as free-standing, ceiling-mounted (Egooo C) or wall-mounted (Egooo W).

Technical features:

Aluminium body

Leuci E27 spot light (it is possible to request a LED lamp from the Life Energy series to replace the standard bulb).





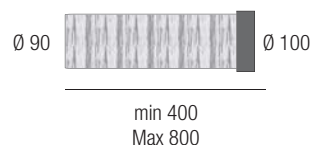
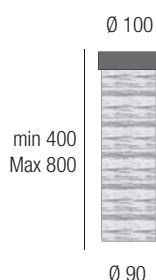
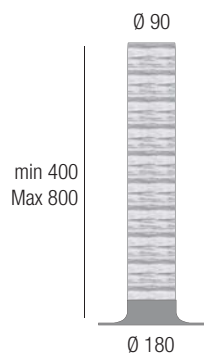

LED EGOO OUTDOOR IP44

Codice *Code*
440315/LED S+L Euro **172,18**

Materiali *Body*



Alluminio lucido (AB)
 Brillant aluminium (AB)

Peso *Weight*
1,35 Kg

Fonti luminose *Light source*



>30.000 h.

36x2W LED E27 220÷240V 3000K

LED EGOO C

Codice *Code*
440115/LED S+L Euro **164,84**

Materiali *Body*



Alluminio lucido (AB)
 Brillant aluminium (AB)

Peso *Weight*
0,8 Kg

Fonti luminose *Light source*



>30.000 h.

36x2W LED E27 220÷240V 3000K

LED EGOO W

Codice *Code*
440215/LED S+L Euro **156,54**

Materiali *Body*



Alluminio lucido (AB)
 Brillant aluminium (AB)

Peso *Weight*
0,57 Kg

Fonti luminose *Light source*



>30.000 h.

36x2W LED E27 220÷240V 3000K



LED **72W** = **100W** Classic



LED **72W** = **100W** Classic



LED **72W** = **100W** Classic





LED EQUAL è una serie di faretti da soffitto e da parete, semplici, geometrici e orientabili sia sull'asse verticale che orizzontale. Il corpo è costituito da due cubi per contenere in uno la sorgente luminosa e nell'altro gli alimentatori. Ideale per il contract ma anche in negozi, abitazioni e uffici. Consigliate per illuminare quadri o oggetti perché non producono nessuna emissione di raggi UV o infrarossi (non scoloriscono o scaldano). Sono disponibili due modelli di diverse misure: Equal, Equal Mini. Disponibile nelle finiture bianco opaco RAL9010 o in nero lucido RAL9005.

Caratteristiche tecniche:

Corpo in alluminio estruso verniciato
Chiusura della sorgente in vetro trasparente temperato (Equal).
Alimentatore elettronico Relco incorporato.
Lampada LED leuci a corredo.

EQUAL LED is a series of ceiling and wall spotlights, simple, geometric and direction-adjustable along both the vertical and horizontal axes. The body is comprised of two cubes, one containing the light source and the other containing the power supply units. Ideal for contract environments, but also shops, homes and offices. Recommended as the lighting system for pictures or objects as they do not produce any UV ray or infra-red emissions (they do not cause fading or heating).

There are two different models in various sizes: Equal, Equal Mini. Available with RAL9010 matt white finish or RAL9005 glossy black.

Technical features:

*Painted extruded aluminium body, Source enclosure in transparent tempered glass (Equal).
Built-in Relco electronic power supply unit.
Leuci LED lamp included.*



Parete Plafone Piantana Incasso | Ceiling Wall Floor Recessed



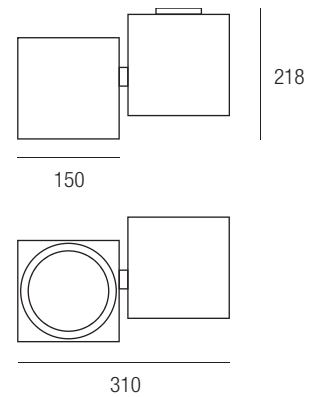
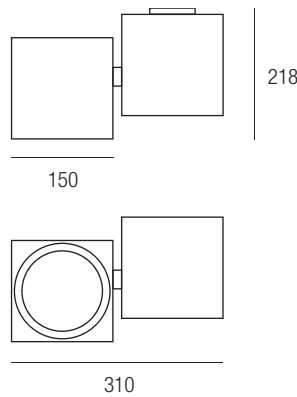
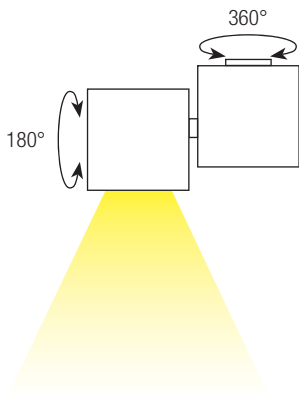

LED EQUAL BIG

Codice	Code	Euro
840102	CELL	328,97
840002	CELL	330,33

Materiali Body



Bianco (WH)
White (WH)

Peso Weight
2,5 Kg

Fonti luminose Light source



>30.000 h.

840102
27W POWERLED 700mA 6000K lens 30°



>30.000 h.

840002
27W POWERLED 700mA 3000K lens 30°

LED EQUAL BIG

Codice	Code	Euro
840101	CELL	330,33
840001	CELL	330,33

Materiali Body



Nero (BK)
Black (BK)

Peso Weight
2,5 Kg

Fonti luminose Light source



>30.000 h.

840101
27W POWERLED 700mA 6000K lens 30°



>30.000 h.

840001
27W POWERLED 700mA 3000K lens 30°



LED **27W** = **100W HALO**



LED **27W** = **100W HALO**



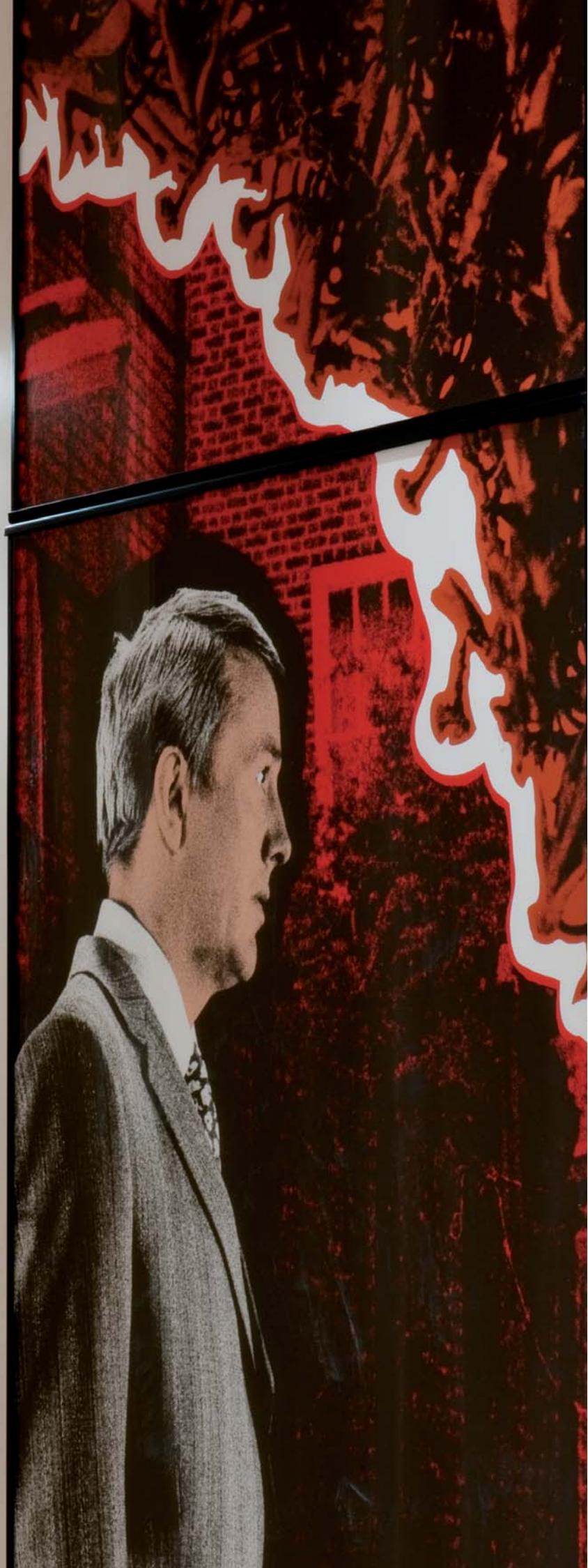

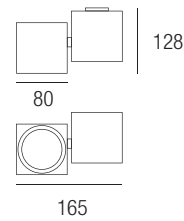
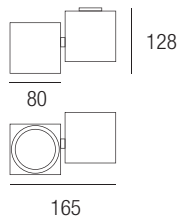
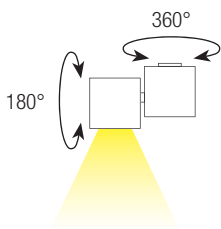

LED EQUAL MINI

Codice	Code	Euro
840702	CELL	165,17
840602	CELL	165,17

Materiali Body



Bianco (WH)
White (WH)

Peso Weight

0,7 Kg

Fonti luminose Light source



>30.000 h.

840702
9W POWERLED 700mA 6000K lens 30°



>30.000 h.

840602
9W POWERLED 700mA 3000K lens 30°

LED EQUAL MINI

Codice	Code	Euro
840701	CELL	165,17
840601	CELL	165,17

Materiali Body



Nero (BK)
Black (BK)

Peso Weight

0,7 Kg

Fonti luminose Light source



>30.000 h.

840701
9W POWERLED 700mA 6000K lens 30°



>30.000 h.

840601
9W POWERLED 700mA 3000K lens 30°



LED **9W** = **50W HALO**



LED **9W** = **50W HALO**





LED ETOILE è un raffinato faretto da soffitto e da parete, orientabile sia sull'asse verticale che orizzontale. La forma semplice ma elegante rende questo prodotto facilmente utilizzabile in molti ambienti come uffici, negozi, abitazioni, alberghi. LED Etoile è molto adatta anche per illuminare quadri o oggetti perchè non producono nessuna emissione di raggi UV o infrarossi (non scoloriscono o scaldano).

Emette una luce diffusa disponibile nelle gradazioni di luce calda o fredda. La struttura può essere nei colori: nero, bianco, oro e alluminio.

Caratteristiche tecniche:

Sorgente a LED Leuci da 27W (equivalente a 100W G53).

Schermo anti-abbagliamento opalino di serie (removibile in caso non servisse).

Alimentatore elettronico Relco incorporato.

Lampada LED Leuci a corredo.

ETOILE LED is a sophisticated ceiling or wall spotlight, which can be adjusted along the vertical or horizontal axis. Its simple but elegant shape makes this product easy to use in most environments such as offices, shops, homes, hotels. Etoile LED is also very suitable as the lighting for pictures or objects because it does not produce any UV ray or infra-red emissions (it does not cause fading or heating).

It produces diffused light, available in warm or cool tones. The structure is available in the following colours: black, white, gold and aluminium.

Technical features:

27W Leuci LED source (equivalent to 100W G53).

Opaline anti-glare screen provided as standard (it can be removed when not needed).

Built-in Relco electronic power supply unit.

Leuci LED lamp included.



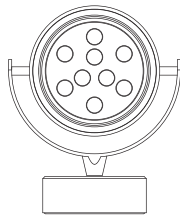

166

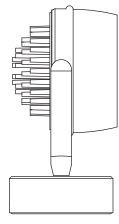

Ø 104

201

LED ETOILE

Codice	Code	Euro
270001	CELL	279,83
270101	CELL	279,83

Materiali *Body*



Nero (BK)
Black (BK)

Peso *Weight*

1,81 Kg

Fonti luminose *Light source*



>30.000 h.

270001
27W POWERLED 700mA 6000K lens 30°



>30.000 h.

270101
27W POWERLED 700mA 3000K lens 30°

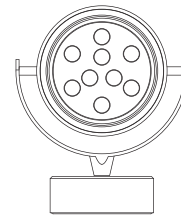

166

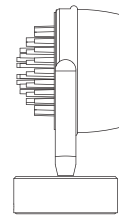

Ø 104

201

LED ETOILE

Codice	Code	Euro
270002	CELL	281,19
270102	CELL	281,19

Materiali *Body*



Bianco (WH)
White (WH)

Peso *Weight*

1,81 Kg

Fonti luminose *Light source*



>30.000 h.

270002
27W POWERLED 700mA 6000K lens 30°



>30.000 h.

270102
27W POWERLED 700mA 3000K lens 30°

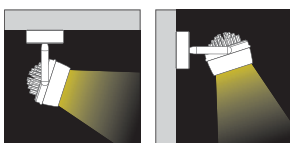

LED **27W** =  **100W HALO**



LED **27W** =  **100W HALO**



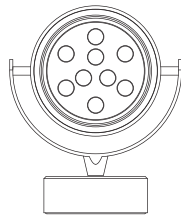

166

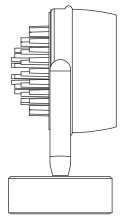

Ø 104

201

LED ETOILE

Codice	Code	Euro
270009	CELL	273,00
270109	CELL	273,00

Materiali *Body*



Oro (GD)
Gold (GD)

Peso *Weight*

1,81 Kg

Fonti luminose *Light source*



>30.000 h.

270009

27W POWERLED 700mA 6000K lens 30°



>30.000 h.

270109

27W POWERLED 700mA 3000K lens 30°

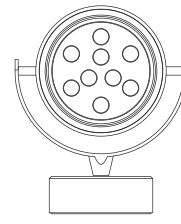

166

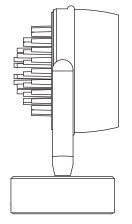

Ø 104

201

LED ETOILE

Codice	Code	Euro
270026	CELL	273,00
270126	CELL	273,00

Materiali *Body*



Alluminio (AA)
Aluminium (AA)

Peso *Weight*

1,81 Kg

Fonti luminose *Light source*



>30.000 h.

270026

27W POWERLED 700mA 6000K lens 30°



>30.000 h.

270126

27W POWERLED 700mA 3000K lens 30°



LED **27W** = **100W HALO**



LED **27W** = **100W HALO**





GIACINTO è una serie di lampade da plafone e da parete. Lineari, semplici, adatte ad ogni spazio, si inseriscono in ogni ambiente in modo discreto e funzionale emettendo una luce diffusa e calda. Adatte per uso abitativo, residenziale, in uffici e aree comuni.

Disponibile in tre lunghezze e in due colori: bianco e argento.

Caratteristiche tecniche:

Struttura in acciaio galvanizzato.

Schermo in vetro opale.

Portalampada in ceramica.

Completo di morsettiera.

Lampada Leuci a corredo.

GIACINTO is a ceiling and wall lamp series. Linear, simple, suitable for any space, they fit into any setting in a discrete and functional manner, providing diffused, warm light. Suitable for the home, residential facilities, offices and common areas.

Available in three lengths and two colours: white and silver.

Technical features:

Galvanised steel structure.

Opal glass screen.

Ceramic lamp holder.

Complete with terminal board.

Leuci lamp included.



Schermo in vetro opale
Shield in opal glass



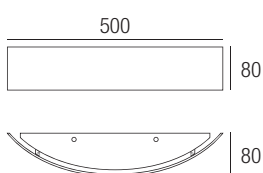

GIACINTO 1

Codice Code Euro
4010/50 S+L (WH) 150,15

Materiali Body

4010/50
Bianco (WH)
White (WH)

Peso Weight
1,5 Kg

Fonti luminose Light source

 120W R7S 230÷240V 50Hz

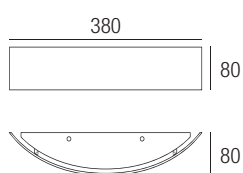

GIACINTO 2

Codice Code Euro
4010/40 S+L (WH) 140,60

Materiali Body

4010/40
Bianco (WH)
White (WH)

Peso Weight
1,1 Kg

Fonti luminose Light source

 80W R7S 230÷240V 50Hz

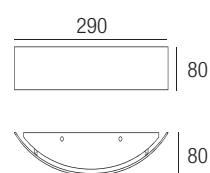

GIACINTO 3

Codice Code Euro
4010/30 S+L (WH) 126,95

Materiali Body

4010/30
Bianco (WH)
White (WH)

Peso Weight
0,9 Kg

Fonti luminose Light source

 80W R7S 230÷240V 50Hz



**-20%
ENERGY**

New HALO **120W** =  **150W** classic



New HALO **80W** =  **100W** classic



New HALO **80W** =  **100W** classic



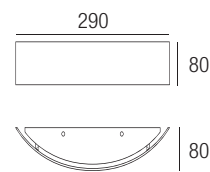
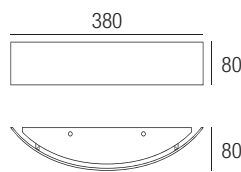
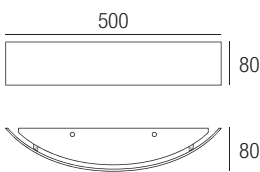

GIACINTO 1

Codice *Code* Euro
4012/2 S+L (AG) 109,20

Materiali *Body*

 **4012/2**
 Argento (AG)
 Silver (AG)

Peso *Weight*
1,5 Kg

Fonti luminose *Light source*

 120W R7S 230÷240V 50Hz

GIACINTO 2

Codice *Code* Euro
4011/1 S+L (AG) 136,96

Materiali *Body*

 **4011/1**
 Argento (AG)
 Silver (AG)

Peso *Weight*
1,1 Kg

Fonti luminose *Light source*

 80W R7S 230÷240V 50Hz

GIACINTO 3

Codice *Code* Euro
4010/1 S+L (AG) 122,98

Materiali *Body*

 **4010/1**
 Argento (AG)
 Silver (AG)

Peso *Weight*
0,9 Kg

Fonti luminose *Light source*



 80W R7S 230÷240V 50Hz



**-20%
ENERGY**

New HALO **120W** =  **150W** classic



New HALO **80W** =  **100W** classic



New HALO **80W** =  **100W** classic





LED GLASS è una serie di lampade semplici, curate e dal design pulito e lineare. Adatte per illuminazione diffusa di qualsiasi ambiente quali salotti, studi, corridoi, vani scale, ecc.

Possono essere installate sia a soffitto che a parete e sono disponibile in due versioni (Glass/GlassG con sporgenza 14cm e Glass25/GlassG25 con sporgenza 24cm) e in misure in vetro opalino curvato e sabbiato (Glass/Glass25 15x12cm e GlassG/GlassG25 30x28cm).

Caratteristiche tecniche:

Struttura in pressofusione di alluminio e ottone nelle finiture cromo o nichel.

Lampada Led Leuci a corredo.

GLASS LED is a series of simple, well-designed lamps with a clean and linear style. They are suitable for providing diffused light environments such as living rooms, studies, corridors, stair-wells, etc.

They can be ceiling or wall-mounted and are available in two versions (Glass/GlassG with 14cm overhang and Glass25/GlassG25 with 24cm overhang) and in various sizes of curved opal and sanded glass (Glass/Glass25 15x12cm and GlassG/GlassG25 30x28cm).

Technical features:

Aluminium and brass die-cast structure with chrome or nickel finish.

Leuci Led lamp included.



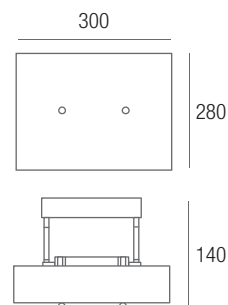
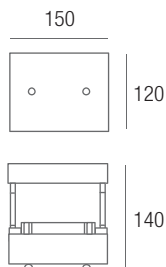

GLASS

LED GLASS

Codice	Code	Euro
190404	S+L (CR)	163,80
190419	S+L (NK)	207,48

Materiali *Body*

190404
Cromo (CR)
Chrome (CR)

190419
Nichel (NK)
Nickel (NK)

Peso *Weight*
0,9 Kg

Fonti luminose *Light source*

>30.000 h.
10W R7S LED 220÷240V 3000K



GLASS G

LED GLASS G

Codice	Code	Euro
190604	S+L (CR)	196,56
190619	S+L (NK)	240,24

Materiali *Body*

190604
Cromo (CR)
Chrome (CR)

190619
Nichel (NK)
Nickel (NK)

Peso *Weight*
1,8 Kg

Fonti luminose *Light source*

>30.000 h.
10W R7S LED 220÷240V 3000K

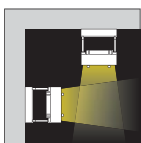

**-20%
ENERGY**

LED **10W** = **100W** classic



LED **10W** = **100W** classic



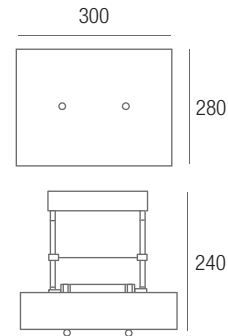
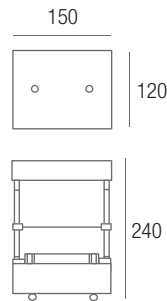

GLASS 25

LED GLASS 25

Codice	Code	Euro
191104	S+L (CR)	204,75
191119	S+L (NK)	253,89

Materiali *Body*

 **191104**
Cromo (CR)
Chrome (CR)

 **191119**
Nichel (NK)
Nickel (NK)

Peso *Weight*
0,85 Kg

Fonti luminose *Light source*

  **>30.000 h.**
10W R7S LED 220÷240V 3000K



GLASS G 25

LED GLASS G 25

Codice	Code	Euro
191204	S+L (CR)	236,15
191219	S+L (NK)	285,29

Materiali *Body*

 **191204**
Cromo (CR)
Chrome (CR)

 **191219**
Nichel (NK)
Nickel (NK)

Peso *Weight*
1,95 Kg

Fonti luminose *Light source*

  **>30.000 h.**
10W R7S LED 220÷240V 3000K

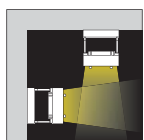

**-20%
ENERGY**

LED **10W** =  **100W** classic



LED **10W** =  **100W** classic





LED GOLF è una serie di apparecchi orientabili moderni e dal design tecnico installabili a parete, a soffitto (Golf) o da incasso per cartongesso (Golf RC). Sono lampade adatte per vetrine di negozi o espositori, corridoi e camere d'albergo. Inoltre le sorgenti a LED da 9W ciascuna ben si prestano ad essere utilizzate in musei, negozi, esposizioni perchè non producono nessuna emissione di raggi UV o infrarossi (non scoloriscono o scaldano gli oggetti). Disponibili in due colori: bianco opaco RAL9010 o in nero opaco RAL9005.

Caratteristiche tecniche:

Corpo in alluminio pressofuso e metallo curvato.
 Chiusura del diffusore in vetro trasparente e lente acrilica prismaticata.
 Alimentatore elettronico Relco incorporato.
 Lampada LED Leuci a corredo.

GOLF LED is a series of modern direction-adjustable light fixtures with a technical design, that can be wall-mounted, ceiling-mounted (Golf) or recessed in plasterboard (Golf RC). These lamps are suitable for shop windows or display cases, corridors and hotel rooms. The LED sources, providing 9W each, are also suitable for use in museums, shops and displays, as they do not produce any UV ray or infra-red emissions (they do not cause objects to fade or heat up). Available in two colours: RAL9010 matt white or RAL9005 matt black.

Technical features:

Die-cast aluminium body and curved metal.
 Transparent glass shade enclosure and prismatic acrylic lens.
 Built-in Relco electronic power supply unit.
 Leuci LED lamp included.



276

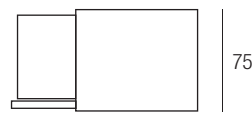

165

LED GOLF

Codice	Code	Euro
830102	CELL	581,49
830002	CELL	581,49

Materiali *Body*

Bianco (WH)
 White (WH)

Peso *Weight*

1,5 Kg

Fonti luminose *Light source*

>30.000 h.
830102
 3x9W POWERLED 700mA 6000K lens 30°

>30.000 h.
830002
 3x9W POWERLED 700mA 3000K lens 30°

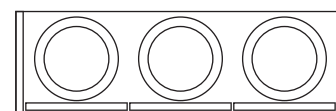

276

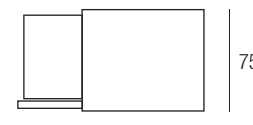

165

LED GOLF

Codice	Code	Euro
830101	CELL	561,02
830001	CELL	561,02

Materiali *Body*

Nero (BK)
 Black (BK)

Peso *Weight*

1,5 Kg

Fonti luminose *Light source*

>30.000 h.
830101
 3x9W POWERLED 700mA 6000K lens 30°

>30.000 h.
830001
 3x9W POWERLED 700mA 3000K lens 30°

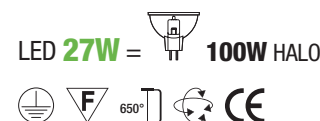
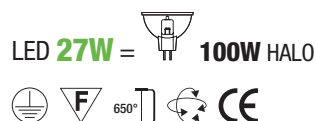
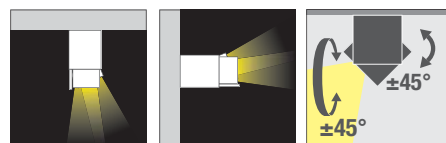



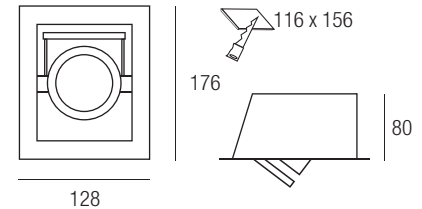
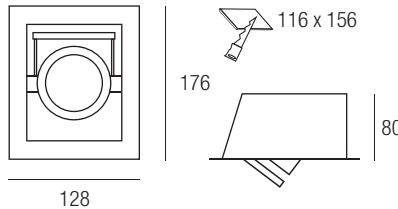

LED GOLF RC

Codice	Code	Euro
830302	CELL	323,51
830202	CELL	267,54

Materiali Body



Bianco (WH)
White (WH)

Peso Weight

0,5 Kg

Fonti luminose Light source



>30.000 h.

830302
9W POWERLED 700mA 6000K lens 30°



>30.000 h.

830202
9W POWERLED 700mA 3000K lens 30°

LED GOLF RC

Codice	Code	Euro
830301	CELL	268,91
830201	CELL	268,91

Materiali Body



Nero (BK)
Black (BK)

Peso Weight

0,5 Kg

Fonti luminose Light source



>30.000 h.

830301
9W POWERLED 700mA 6000K lens 30°



>30.000 h.

830201
9W POWERLED 700mA 3000K lens 30°

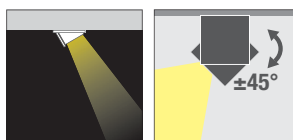

LED **9W** =  **40W HALO**



LED **9W** =  **40W HALO**



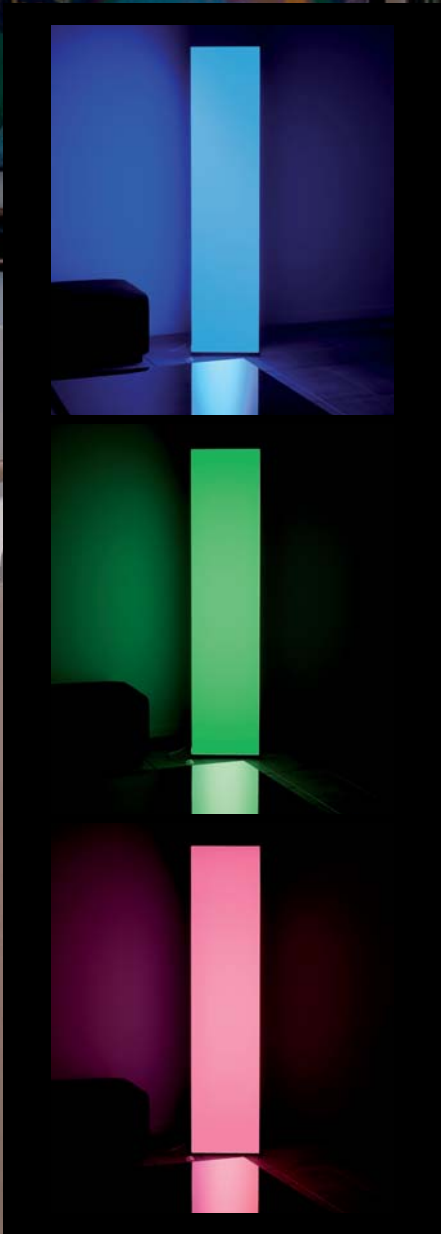
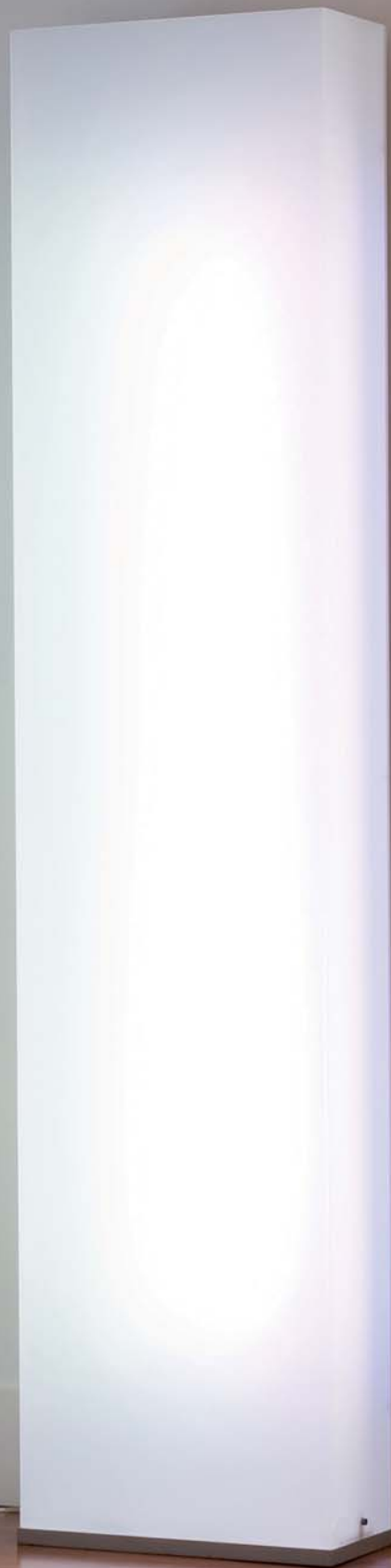
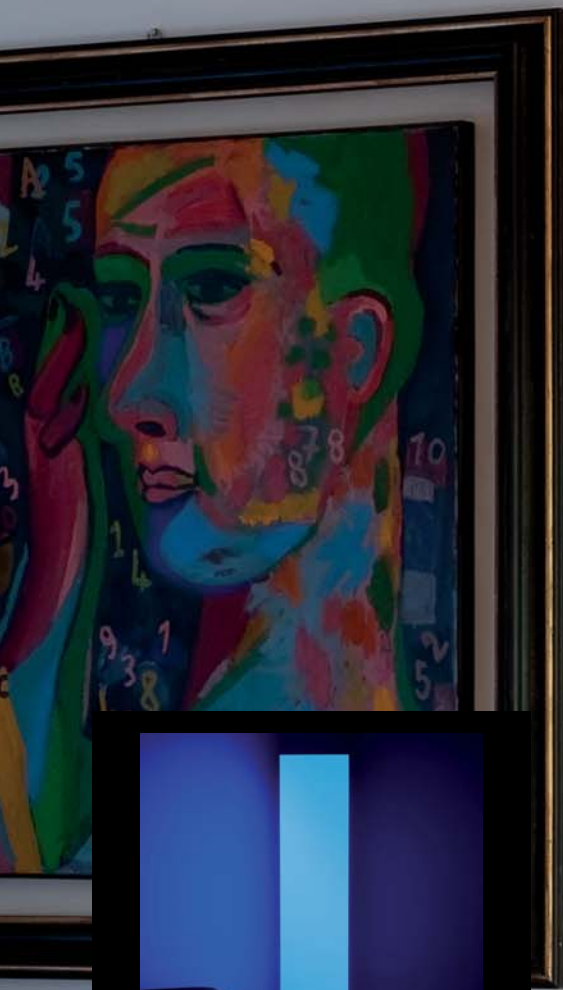



Terra | Floor

LED L'ARCOBALENO

Gianni Bellato



Parete | Wall | Wand

LED ARCOBALENO è una lampada da arredo lineare, geometrica, semplice ma al contempo funzionale perché cambia colore grazie ai LED full color e all'alimentatore elettronico di ultima generazione. Una lampada che arreda, crea atmosfera, dona buon umore, suscita emozioni così come hanno dimostrato numerosi studi sulla cromoterapia, sull'ayurvedica e la teoria del colore di Wolfgang Goethe. E' disponibile in due modelli.

L'Arcobaleno W è destinata ad installazione a parete-soffitto sia con sviluppo verticale o orizzontale, L'Arcobaleno F è in esecuzione da terra.

Caratteristiche tecniche:

Corpo in lastra di plexiglass opalino termoformato

Alimentatore incluso

ARCOBALENO LED is a linear, geometric and simple yet functional decor lamp that changes colour thanks to its full colour LEDs and last-generation electronic power supply unit. This lamp decorates, creates atmosphere, puts you in a good mood and brings out your emotions, as proven by numerous studies on chromotherapy, Ayurvedic medicine and Wolfgang Goethe's theory of colours. It is available in two models. Arcobaleno W is intended for vertical or horizontal wall or ceiling installation, while Arcobaleno F is a floor lamp.

Technical features:

Body made with a thermoformed opal plexiglass sheet

Power supply unit included

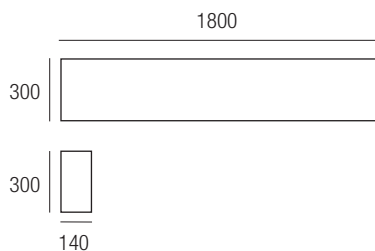
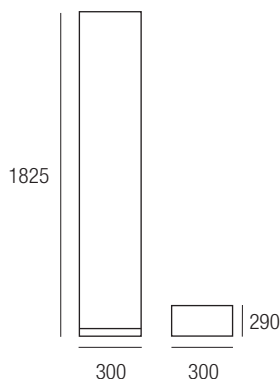

Regolazione tramite pulsante
Regulation button

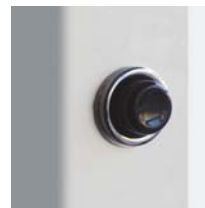

La regolazione della tonalità del colore avviene tramite pulsante incorporato che permette di ottenere:

- luce bianca
- tonalità prescelta fissa
- variazione ciclica dei colori

The adjustment of the shades of the color occurs via built-in button that allows to obtain:

- white light
- selected color shade fixed
- cyclic variation of colors

LED L'ARCOBALENO W

Codice	Code	Euro
270100	CELL-D	1078,35

Materiali Body



Bianco (WH)
White (WH)

Peso Weight

25 Kg

Fonti luminose Light source



>30.000 h.

40W LED RGB FULLCOLOR

LED L'ARCOBALENO W

Codice	Code	Euro
270200	CELL-D	941,85

Materiali Body



Bianco (WH)
White (WH)

Peso Weight

15 Kg

Fonti luminose Light source



>30.000 h.

40W LED RGB FULLCOLOR



LED **40W** = **1x250W** classic





Applique dal design essenziale e geometrico. Semplicità e purezza la rendono molto versatile nelle diverse applicazioni sia in ambienti privati, che residenziali. Il diffusore in vetro opalino lascia scorrere la luce fluida e morbida, con diffusione della luce anche su due lati a creare una luce d'accento sulla parete.

Caratteristiche tecniche:

Corpo in lamiera di acciaio.

Verniciatura di tipo poliestere eseguita a polvere.

Ottica in alluminio metallizzato sotto vuoto.

Schermo interno in vetro in lastra serigrafata, sabbato esternamente.

Cablaggio con portalampada E27 (LED Arco) dotato di morsettiera 3 poli e 2 portalampada E27(LED Conca).

Wall lamp featuring a basic and geometric basic. Its simplicity and purity make it very versatile in various applications, in private and residential spaces. The opaline glass diffuser lets the light flow fluidly and softly. The light is also diffused on both sides to create an accent light on the wall.

Technical features:

Sheet steel body.

Painting: powder polyester coating.

Vacuum-metallised aluminium optic.

With glass slab screen with screen-printing on the inside, sandblasted on the outside.

Cabling with E27 lamp holder (Arco LED) fitted with a 3-pole terminal board and 2 E27 lamp holders (Conca LED).



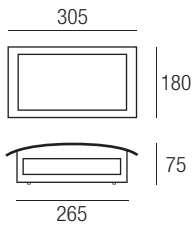

LED ARCO

Codice *Code*
32181/LED **S+L** Euro **136,50**

Materiali *Body*



Argento (AG)
 Silver (AG)

Peso *Weight*
2,2 Kg

Fonti luminose *Light source*



>30.000 h.

8W LED E27 230÷240 3000K lens 300°

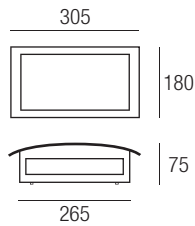

LED ARCO

Codice *Code*
32182/LED **S+L** Euro **136,50**

Materiali *Body*



Nero (BK)
 Black (BK)

Peso *Weight*
2,2 Kg

Fonti luminose *Light source*



>30.000 h.

8W LED E27 230÷240 3000K lens 300°

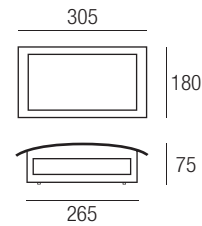

LED ARCO

Codice *Code*
32183/LED **S+L** Euro **136,50**

Materiali *Body*



Bianco (WH)
 White (WH)

Peso *Weight*
2,2 Kg

Fonti luminose *Light source*



>30.000 h.

8W LED E27 230÷240 3000K lens 300°



LED **8W** = **100W** classic



LED **8W** = **100W** classic



LED **8W** = **100W** classic



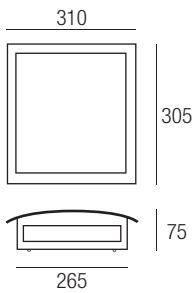

LED CONCA

Codice *Code*
32171/LED **S+L** Euro **204,75**

Materiali *Body*



Argento (AG)
 Silver (AG)

Peso *Weight*
3,6 Kg

Fonti luminose *Light source*



>30.000 h.

2x8W LED E27 230÷240 3000K lens 300°

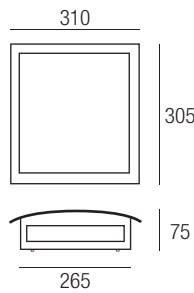

LED CONCA

Codice *Code*
32172/LED **S+L** Euro **204,75**

Materiali *Body*



Nero (BK)
 Black (BK)

Peso *Weight*
3,6 Kg

Fonti luminose *Light source*



>30.000 h.

2x8W LED E27 230÷240 3000K lens 300°

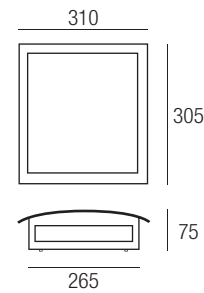

LED CONCA

Codice *Code*
32173/LED **S+L** Euro **204,75**

Materiali *Body*



Bianco (WH)
 White (WH)

Peso *Weight*
3,6 Kg

Fonti luminose *Light source*



>30.000 h.

2x8W LED E27 230÷240 3000K lens 300°



LED **8W** =  **100W** classic



LED **8W** =  **100W** classic



LED **8W** =  **100W** classic





LED CUBE 1G è un moderno ed innovativo apparecchio a led per interni. Dal design minimale, geometrico e piacevole, ben si inserisce in ogni ambiente. Un'altra particolarità è la doppia emissione di luce verso il basso e verso l'alto. Nel corpo illuminante, infatti, è presente un semplicissimo cut off meccanico che consente, in modo indipendente e senza l'utilizzo di attrezzi, la regolazione angolare dei fasci luminosi emessi da ciascuna delle due sorgenti. La limitata sporgenza dal muro e le basse temperature superficiali consentono, dove fosse necessario, installazioni anche ad altezze ridotte.

Caratteristiche tecniche:

Corpo, rosone ed attacco a parete in lastra d'acciaio spessore (3mm) tagliato e lavorato meccanicamente.
 Finitura superficiale con vernice a polvere di colore bianco opaco con finitura gofrata RAL 9010.
 Alimentatore elettronico Relco incorporato.

CUBE LED 1G is a modern and innovative led light fixture for interiors. Featuring a minimal, geometric and appealing design, it fits well into any context. Another distinguishing feature is its dual light output, downwards and upwards. In fact, the lamp has a simple mechanical cut-off that makes it possible to adjust the output angle of the light beams from each of the two sources, without the use of any tools. The limited overhang from the wall and low surface temperatures allow for low installation as well if required.

Technical features:

*Mechanically-machined and cut steel plate body (3mm thick), ceiling cup and wall fitting.
 Surface finish with white matt powder paint with RAL 9010 embossed finish.
 Built-in Relco electronic power supply unit.*

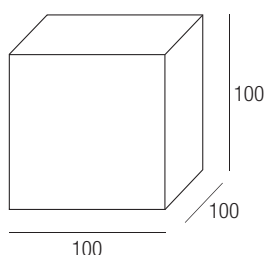

**ESEMPI DI ORIENTAMENTO
 ORIENTATION EXAMPLE**



LED CUBE 1G

Codice Code Euro
88/A1 CELL 245,70

Materiali Body



Bianco (WH)
 White (WH)

Peso Weight
0,87 Kg

Fonti luminose Light source



>30.000 h.

3+3W LED 350mA 3000K CRI 85

LED **3+3W** =  **40W HALO**



100÷240V - 50/60Hz



LED CUBE 2P è un apparecchio di illuminazione a led da interno per installazione fissa a parete che trova la propria corretta applicazione in locali dove è richiesto un punto a luce diffusa verso l'alto ed il basso. Può essere installato anche ad altezze ridotte e il design minimale e discreto lo rende adatto ad ogni ambiente. Grazie ad un semplice cut off meccanico posto sul corpo della lampada, è possibile la regolazione angolare dei fasci luminosi emessi da ciascuna delle due sorgenti.

Caratteristiche tecniche:

Corpo, rosone ed attacco a parete in lastra d'acciaio spessore (3mm) tagliato e lavorato meccanicamente.
 Finitura superficiale con vernice a polvere di colore bianco opaco con finitura gofrata RAL 9010.
 Alimentatore elettronico Relco incorporato.

CUBE 2P LED is an indoor light fixture for fixed wall installation. Suitable for rooms where a diffused light source directed both upwards and downwards is required. It can also be installed at low heights, and its minimal and discrete design make it suitable for any setting. Thanks to a simple mechanical cut-off built onto the body of the lamp, it is possible to adjust the output angle of the light beams from the two sources.

Technical features:

*Mechanically-machined and cut steel plate body (3mm thick), ceiling cup and wall fitting.
 Surface finish with white matt powder paint with RAL 9010 embossed finish.
 Built-in Relco electronic power supply unit.*

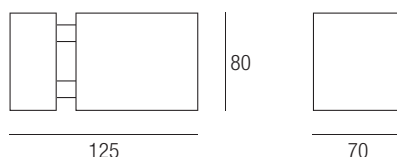

**ESEMPI DI ORIENTAMENTO
 ORIENTATION EXAMPLE**



LED CUBE 2P

Codice Code Euro
103/A1 CELL 261,30

Materiali Body



Bianco (WH)
 White (WH)

Peso Weight

0,67 Kg

Fonti luminose Light source



>30.000 h.

3+3W LED 350mA 3000K CRI 85

LED **3+3W** =  **40W HALO**



100÷240V - 50/60Hz



LED LINE è una moderna lampada da parete. Design innovativo, lineare, geometrico, purezza di forme, si inserisce in modo discreto in qualsiasi ambiente abitativo, ufficio, contract. L'emissione luminosa è a luce diffusa verso l'alto. La limitata sporgenza dal muro e le basse temperature superficiali consentono, dove fosse necessario, installazioni anche ad altezze ridotte. Finitura superficiale con vernice a polvere di colore bianco opaco con finitura gofrata RAL 9010.

Caratteristiche tecniche:

Corpo in lastra d'acciaio spessore (5mm) tagliata, piegata e lavorata meccanicamente, attacco a parete in metallo piegato. Alimentatore elettronico Relco incorporato.

LINE LED is a modern wall lamp. It features an innovative, linear, geometric design with a pure shape. It fits in discretely in the home, office or contract environments. It emits diffused light upwards. The limited overhang from the wall and low surface temperatures allow for low installation as well if required. Surface finish with white matt powder paint with RAL 9010 embossed finish.

Technical features:

The body is made with mechanically-machined, cut, and bent (5 mm thick) steel sheet, while the wall fixture is made with bent metal. Built-in Relco electronic power supply unit.



LED LINE

Codice *Code* Euro
84/A1 **CELL** **313,95**

Materiali *Body*

Bianco (WH)
 White (WH)

Peso *Weight*
0,75 Kg

Fonti luminose *Light source*

 **>30.000 h.**
 6W LED 3000K CRI 80



LED **6W** =  **40W HALO**

   **220÷240V - 50/60Hz**

 lighting technologies



LED Leon è un'elegante applique da interni in vetro opale disponibile in due colori: bianco e nero. Grazie alla semplicità della forma si presta per illuminare con stile ambienti residenziali, corridoi, parti comuni di uffici e scale. L'emissione luminosa è calda e avvolgente e si diffonde verso l'alto.

Caratteristiche tecniche:

Corpo in vetro opale
Sorgente a Led Leuci 8W

Leon LED is an elegant opal glass wall lamp for interiors, available in two colours: white and black. Thanks to its simple shape, it is well-suited to light residential spaces, corridors, common areas of offices and stair-wells, in style. It emits a warm and enveloping light, directed upwards.

Technical features:

Opal glass body.
8W Leuci Led source

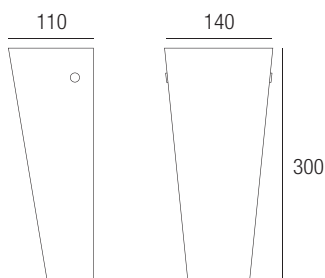

LED LEON

Codice *Code*
13/A1BIA/LED S+L Euro **287,95**

Materiali *Body*



Bianco (WH)
White (WH)

Peso *Weight*
0,8 Kg

Fonti luminose *Light source*



>30.000 h.

8W LED E27 220÷240V 50Hz 3000K



42W Halo E27 220÷240V 50Hz

LED LEON

Codice *Code*
13/A1NER/LED S+L Euro **287,95**

Materiali *Body*



Nero (BK)
Black (BK)

Peso *Weight*
0,8 Kg

Fonti luminose *Light source*



>30.000 h.

8W LED E27 220÷240V 50Hz 3000K



42W Halo E27 220÷240V 50Hz



LED **8W** = **60W** classic



LED **8W** = **60W** classic





Scudo LED è una lampada da parete esteticamente piacevole che ben si inserisce in tutti gli ambienti e stili. E' una lampada da interni, facile da installare e di peso contenuto, molto adatta per illuminare corridoi, soggiorni, spazi abitativi così come residenziali, uffici e scale. Disponibile in tre finiture: bianco, oro o argento.

Caratteristiche tecniche:

Struttura in vetro
Sorgente Led Leuci 8W inclusa

Scudo LED is an aesthetically appealing wall lamp that fits well into any setting and style. This wall lamp is designed for interiors. It is easy to install and moderate in weight, highly suited to light corridors, living rooms, living spaces as well as residential areas, offices and stairs. Available in three finishes: white, gold and silver.

Technical features:

Glass structure
8W Leuci Led source included

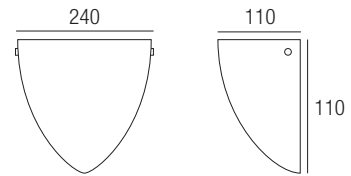
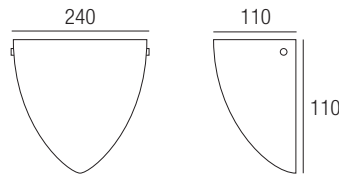
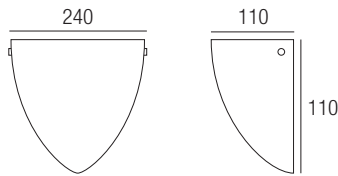

LED SCUDO

Codice *Code*
990/BIA/LED S+L 136,50

Materiali *Body*



Bianco (WH)
White (WH)

Peso *Weight*
0,5 Kg

Fonti luminose *Light source*



>30.000 h.

8W LED E27 220÷240V 50Hz 3000K



42W Halo E27 220÷240V 50Hz

LED **8W** = **60W** classic



LED SCUDO

Codice *Code*
990/ORO/LED S+L 143,00

Materiali *Body*



Oro (GD)
Gold (GD)

Peso *Weight*
0,5 Kg

Fonti luminose *Light source*



>30.000 h.

8W LED E27 220÷240V 50Hz 3000K



42W Halo E27 220÷240V 50Hz

LED **8W** = **60W** classic



LED SCUDO

Codice *Code*
990/ARG/LED S+L 143,00

Materiali *Body*



Argento (AG)
Silver (AG)

Peso *Weight*
0,5 Kg

Fonti luminose *Light source*



>30.000 h.

8W LED E27 220÷240V 50Hz 3000K



42W Halo E27 220÷240V 50Hz

LED **8W** = **60W** classic





LED OVALE e LED QUADRO sono lampade da parete per applicazioni d'interno. Con sorgente a led, coniugano il design semplice e raffinato al risparmio energetico garantito. Lineari e armoniose, ben si collocano in qualsiasi ambiente: abitazioni, uffici, alberghi.

Caratteristiche tecniche:

corpo in alluminio
sorgente led

LED OVALE and LED QUADRO are wall lamps for interior applications. With a LED light source, it combines simple and elegant design with guaranteed energy saving. Linear and harmonious, it fits well in any environment: houses, offices, hotels.

Technical features:

Aluminium body
LED light source

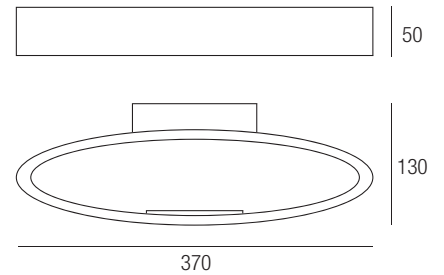
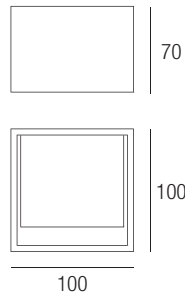

LED QUADRO

Codice	Code		Euro
105/AARG	S+L (AG)		286,00
105/AORO	S+L (GD)		286,00

Materiali *Body*



Peso *Weight*
0,6 Kg

Fonti luminose *Light source*



6W LED 220÷240V 50Hz

LED OVALE

Codice	Code		Euro
79/AARG	S+L (AG)		318,50
79/AORO	S+L (GD)		318,50
79/ABIA	S+L (WH)		299,00

Materiali *Body*

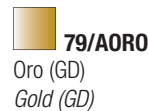

Peso *Weight*
0,9 Kg

Fonti luminose *Light source*



12W LED 220÷240V 50Hz



LED **6W** = **30W** classic



LED **12W** = **60W** classic







POINT HALO - LED POINT

Parete Plafone | Wall Ceiling

Alan Foster

POINT - LED POINT è una lampada da parete e plafone a luce diffusa dal design semplice, cilindrico, moderno che ben si inserisce in tutti gli ambienti adattandosi a qualsiasi stile. Di dimensioni e peso ridotti può essere installata da sola o in più apparecchi a seconda della superficie da illuminare.

Caratteristiche tecniche:

Struttura in metallo.

Finiture nichel spazzolato, cromo o verniciato bianco opaco.

Diffusore in vetro sabbato.

Sorgenti Leuci incluse: lampada alogena a risparmio energetico G9 e lampada a led.

POINT - LED POINT is a diffused light wall and ceiling lamp with a simple, cylindrical, modern design that fits well into any room, adapting to any style. With its reduced size and weight, it can be installed on its own or in combination with multiple fixtures, depending on the surface requiring lighting.

Technical features:

Metal structure.

Brushed nickel, chrome or matt white painted finishes

Sanded glass shade.

Leuci sources included: G9 halogen energy saving lamp and led lamp.



Parete Plafone Piantana Incasso | Ceiling Wall Floor Recessed







POINT HALO - LED POINT

Parete Plafone | Wall Ceiling

Alan Foster

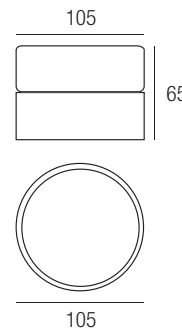
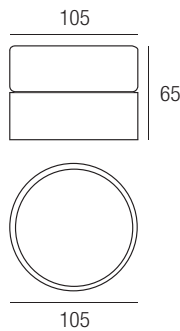
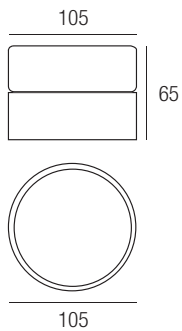

LED POINT

Codice	Code	S+L	Euro
430002		S+L	84,63
430002/LED		CELL	82,55

Materiali Body



Bianco (WH)
White (WH)

Peso Weight
0,65 Kg

Fonti luminose Light source



33W G9 230V 3000K



>30.000 h.

4,3W LED 230V 3000K 330Lm

LED POINT

Codice	Code	S+L	Euro
430004		S+L	92,82
430004/LED		CELL	85,99

Materiali Body



Cromo (CR)
Chrome (CR)

Peso Weight
0,65 Kg

Fonti luminose Light source



33W G9 230V 3000K



>30.000 h.

4,3W LED 230V 3000K 330Lm

LED POINT

Codice	Code	S+L	Euro
430019		S+L	99,65
430019/LED		CELL	93,47

Materiali Body



Nichel (NK)
Nickel (NK)

Peso Weight
0,65 Kg

Fonti luminose Light source



33W G9 230V 3000K



>30.000 h.

4,3W LED 230V 3000K 330Lm

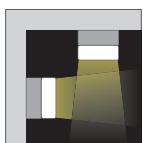

LED **4,3W** = **40W** Classic





LED ROCK è un originale lampada da parete e plafone dal design moderno e funzionale, dotata di riflettore orientabile a 360° che permette di direzionare il flusso luminoso. Disponibile in due versioni con diverse sporgenze (13cm Rock, 23cm Rock 25) e con finiture cromo o nichel.

Caratteristiche tecniche:

Struttura in pressofusione di alluminio e ottone.
Riflettore in alluminio anodizzato opaco.
Lampada Leuci LED + New HALO a corredo.

ROCK LED is a unique wall and ceiling lamp with a modern and functional design, equipped with a 360° direction-adjustable reflector, making it possible to direct the flow of light. Available in two versions with different overhangs (13cm Rock, 23cm Rock 25), with chrome or nickel finishes.

Technical features:

Aluminium or brass die-cast structure.
Matt anodised aluminium reflector.
LED Leuci + New HALO lamp included.

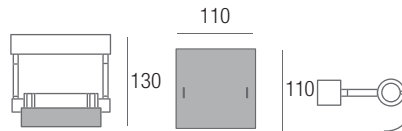
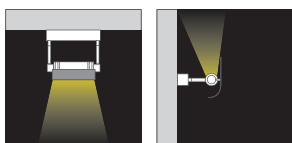
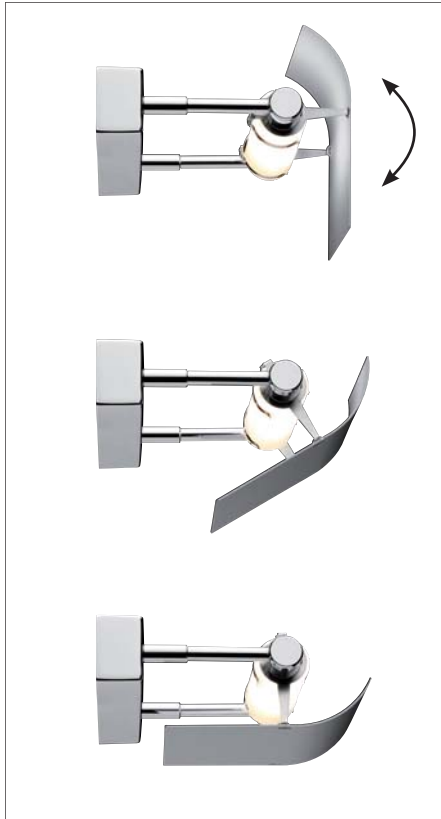

LED ROCK

Codice	Code	Euro
190804	S+L (CR)	141,96
190819	S+L (NK)	196,56

Materiali *Body*

 **190804**
Cromo (CR)
Chrome (CR)

 **190819**
Nichel (NK)
Nickel (NK)

Peso *Weight*
0,65 Kg

Fonti luminose *Light source*

  **>30.000 h.**
10W R7S LED 220÷240V 3000K

 **>2.000 h.**
80W R7S 220÷240V 80 mm. 1400Lm

LED **10W** =  **100W** classic

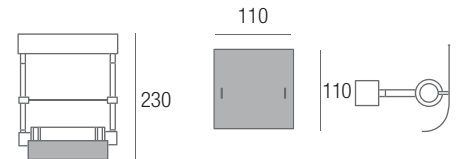

LED ROCK 25

Codice	Code	Euro
191304	S+L (CR)	210,21
191319	S+L (NK)	259,35

Materiali *Body*

 **191304**
Cromo (CR)
Chrome (CR)

 **191319**
Nichel (NK)
Nickel (NK)

Peso *Weight*
0,75 Kg

Fonti luminose *Light source*

  **>30.000 h.**
10W R7S LED 220÷240V 3000K

 **>2.000 h.**
80W R7S 220÷240V 80 mm. 1400Lm

LED **10W** =  **100W** classic





STICK è una lampada da parete e plafone dal design semplice e moderno. Molto compatta e leggera, è disponibile in due versioni con sporgenze diverse (12cm Stick, 21cm Stick 25). Emette una luce calda ed avvolgente che ben si presta per illuminare corridoi, disimpegni e ambienti abitativi. Disponibili in due finiture: cromo e nichel.

Caratteristiche tecniche:

Struttura in pressofusione di alluminio e ottone.
Lampada Leuci New Halo 80W a corredo.

STICK is a wall and ceiling lamp featuring a simple and modern design. It is very compact and light, available in two versions with different overhangs (12cm Stick, 21cm Stick 25). It emits a warm and enveloping light that is highly suitable for corridors, vestibules and living spaces. Available in two finishes: chrome and nickel.

Technical features:

Aluminium or brass die-cast structure.
80W New Halo Leuci lamp included.

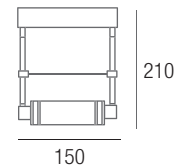
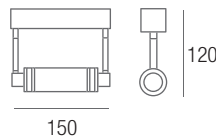

STICK

Codice	Code	Euro
190204	S+L (CR)	126,95
190219	S+L (NK)	163,80

Materiali *Body*

 **190204**
Cromo (CR)
Chrome (CR)

 **190219**
Nichel (NK)
Nickel (NK)

Peso *Weight*
0,55 Kg

Fonti luminose *Light source*

 **2.000 h.**
80W R7S 220÷240V 80 mm. 1400Lm

STICK 25

Codice	Code	Euro
191004	S+L (CR)	170,63
191019	S+L (NK)	218,40

Materiali *Body*

 **191004**
Cromo (CR)
Chrome (CR)

 **191019**
Nichel (NK)
Nickel (NK)

Peso *Weight*
0,7 Kg

Fonti luminose *Light source*

 **2.000 h.**
80W R7S 220÷240V 80 mm. 1400Lm



STICK



STICK 25

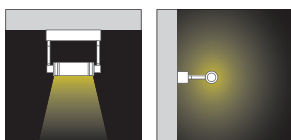

New HALO **80W** =  **100W** classic



New HALO **80W** =  **100W** classic





LED TABLOID è una lampada da parete e plafone, semplice, moderna adatta a tutti gli ambienti che ben si sposa con qualsiasi stile, dal più moderno al più classico. Emette una calda luce diffusa che illumina gli spazi con discrezione.

Caratteristiche tecniche:

Struttura in metallo verniciato argento.
Diffusori in vetro serigrafato e curvato finitura liscio.
Lampada Leuci Led 8W a corredo

TABLOID LED is a simple, modern wall and ceiling lamp, suitable for any space and goes well with any style, ranging from modern to classic. It provides a warm, diffused light that illuminates spaces discretely.

Technical features:

*Silver painted metal structure.
Curved and screen-printed glass shades with smooth finish.
8W Led Leuci lamp included*

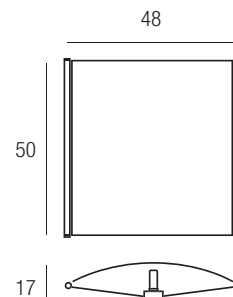

LED TABLOID 50

Codice Code Euro
341017/LED S+L xxxxx

Materiali Body



Argento (AG)
Silver (AG)

Peso Weight

5,7 Kg

Fonti luminose Light source



8W E27 230V 3000K



120W E27 230V 3000K

LED **8W** =  **60W** classic



lighting technologies





 Incasso | Recessed

 Parete | Wall | Wand

LED TA-TA

Diego Vencato

LED TA-TA è una simpatica e moderna lampada da parete (Ta-Ta W) o da incasso (Ta-Ta RC). Semplice, minimale, di forma quadrata, si inserisce in ambienti moderni e di stile. Emette una luce calda e discreta, indiretta e diffusa grazie alla particolare inclinazione dello schermo frontale. E' disponibile in due misure e con due differenti potenze luminose. Finitura in bianco RAL 9010.

Caratteristiche tecniche:

Struttura in metallo verniciato.

Alimentatore elettronico Relco incorporato.

Lampada Led Leuci a corredo.

TA-TA LED is a simple and modern wall (Ta-Ta W) or recessed (Ta-Ta RC) lamp. Simple, minimal, square-shaped, it is well suited to modern and stylish spaces. It provides a warm and discrete, indirect and diffused light thanks to the special tilt of the front screen. It comes in two sizes and with two different light intensities. RAL 9010 white finish.

Technical features:

Painted metal structure.

Built-in Relco electronic power supply unit.

Leuci Led lamp included.



Parete Plafone Piantana Incasso | Ceiling Wall Floor Recessed

LED TA-TA W

Diego Vencato

Parete | Wall | Wand

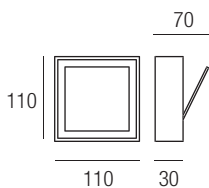

LED TA-TA W SMALL

Codice Code Euro
590302/LED CELL 121,49

Materiali Body



Bianco (WH)
 White (WH)

Peso Weight
0,9 Kg

Fonti luminose Light source



>30.000 h.

4W POWERLED 350mA 3000K lens 120°

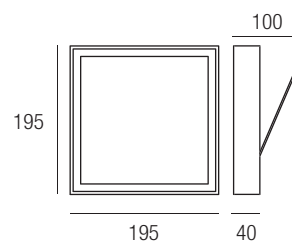

LED TA-TA W

Codice Code Euro
590002/LED S+L 233,42

Materiali Body



Bianco (WH)
 White (WH)

Peso Weight
2,3 Kg

Fonti luminose Light source



>30.000 h.

10W POWERLED R7S 220÷240V 3000K lens 360°



LED **4W** =  **20W** classic



LED **10W** =  **100W** classic



lighting technologies

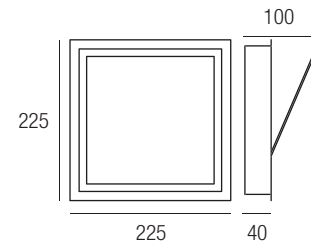
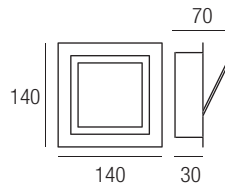

LED TA-TA RC SMALL

Codice *Code*
590202/LED CELL Euro **147,42**

Materiali *Body*



Bianco (WH)
 White (WH)

Peso *Weight*
1 Kg

Fonti luminose *Light source*



>30.000 h.

4W POWERLED 350mA 3000K lens 120°

LED TA-TA RC

Codice *Code*
590102/LED S+L Euro **267,54**

Materiali *Body*



Bianco (WH)
 White (WH)

Peso *Weight*
2,5 Kg

Fonti luminose *Light source*



>30.000 h.

10W POWERLED R7S 220÷240V 3000K lens 360°

Parete Plafone Piantana Incasso | Ceiling Wall Floor Recessed



LED **4W** =  **20W** classic



LED **10W** =  **100W** classic





LED THEO è una lampada moderna, semplice e d'effetto. Ideata per un'installazione a soffitto si presta anche ad una installazione a semi-incasso mediante l'utilizzo dell'accessorio Theo recessing kit. Funzionale e visivamente poco ingombrante e leggera, ben si inserisce in ambienti domestici e nel contract. Emette una luce calda e avvolgente grazie ad un diffusore cilindrico in vetro parzialmente sabbiato.

Disponibile nelle finiture cromo e nichel.

Caratteristiche tecniche:

Struttura in metallo.

Diffusore cilindrico in vetro Pyrex.

Trasformatore incluso esterno all'apparecchio (dovrà essere posizionato in cassetta di derivazione separata oppure in controsoffitto).

Alimentatore elettronico Relco incorporato.

Lampada Led Leuci a corredo.

THEO LED is a modern, simple lamp that is sure to impress. Created for ceiling installation, it is also suitable for semi-recessed installation using the Theo recessing kit accessory. Functional, visually non-invasive and light, it is well-suited for the home and contract environments. It provides a warm and enveloping light thanks to its partially-sanded cylindrical glass shade.

Available in chrome and nickel finishes.

Technical features:

Metal structure.

Cylindrical Pyrex glass shade.

Transformer included, external to the fixture (it needs to be set up in a separate shunt box or in the false ceiling).

Built-in Relco electronic power supply unit.

Leuci Led lamp included.

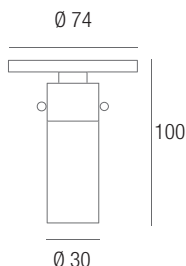

LED THEO

Codice	Code	Euro
110004/LED	CELL (CR)	76,44
110019/LED	CELL (NK)	73,71

Materiali *Body*

 **110004/LED**
Cromo (CR)
Chrome (CR)

 **110019/LED**
Nichel (NK)
Nickel (NK)

Peso *Weight*
0,21 Kg

Fonti luminose *Light source*

 **>30.000 h.**
1,5W LED G4 220÷240V 3000K lens 40°



ACCESSORIO *ACCESSORY*

THEO RECESSING KIT

Codice	Code	Euro
115101		6,15

Materiali *Body*

 **Nero (BK)**
Black (BK)

Peso *Weight*
0,02 Kg

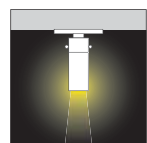

LED **1,5W** =  **10W** classic





OLIVIA è una semplice e moderna lampada da terra. Molto versatile e dal design lineare. La forma cilindrica è impreziosita dalla presenza di uno snodo meccanico che consente di inclinare e ruotare la parte superiore della lampada così da adattare il flusso luminoso alle proprie esigenze: luce diretta per illuminare un piano o indiretta e diffusa per illuminare e avvolgere l'ambiente in cui è inserita. Adatta per ambienti domestici e uffici, è dotata di un dimmer che permette di variare l'intensità luminosa.

Caratteristiche tecniche:

Corpo è metallo finitura bianco opaco

Diffusore è in tecnopolimero estruso opalino

L'alimentatore elettronico dimmerabile (Relco) contenuto nella parte inferiore della lampada.

OLIVIA is a simple and modern floor lamp. It is very versatile and features a linear design. Its cylindrical shape is embellished with a mechanical joint so that the top part of the lamp can be tilted and turned, adapting the flow of light as needed: direct light to light up a surface or indirect and diffused to light up and envelope the room it is installed in. Suitable for home and office environments, it is equipped with a dimmer to adjust the light intensity.

Technical features:

The body is made with opal white finish metal

The shade is made with opal extruded technopolymer

The dimmable electronic power supply unit (Relco) is contained in the bottom part of the lamp.

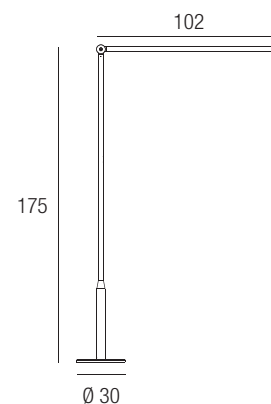
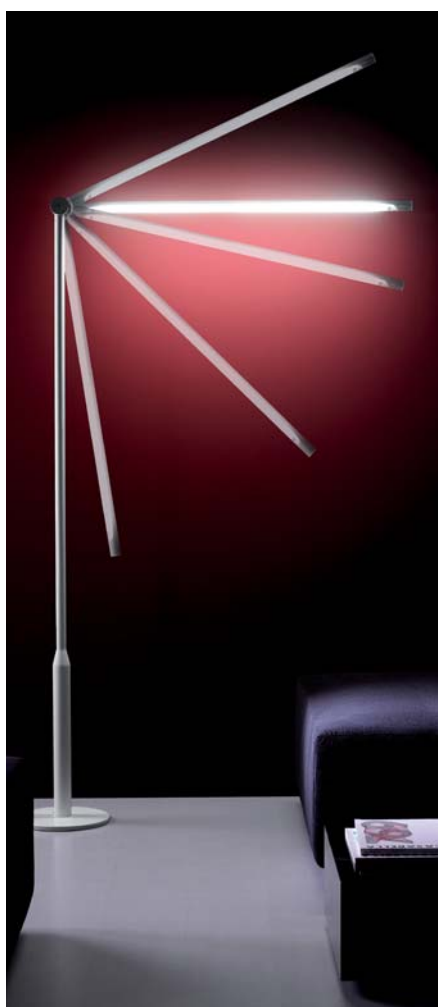
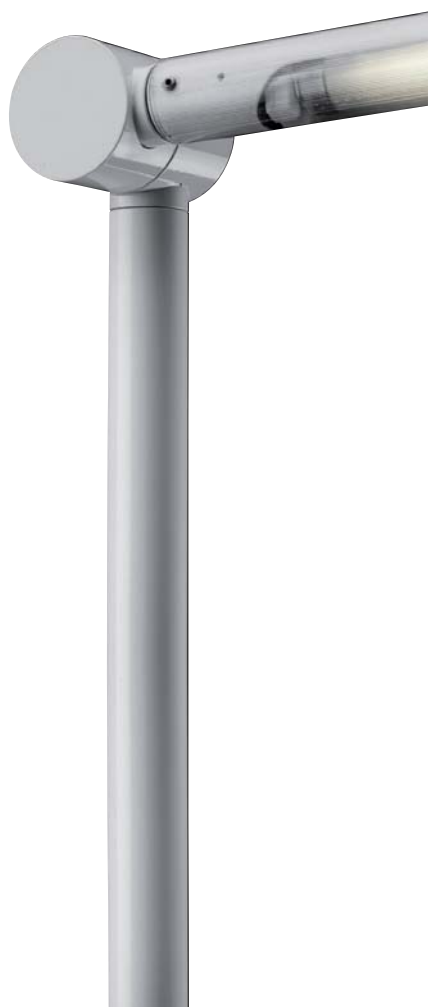

OLIVIA

Codice	Code	Euro
810002	CELL-D	1213,49

Materiali *Body*



Bianco (WH)
White (WH)

Peso *Weight*

8,5 Kg

Fonti luminose *Light source*



39W G5 T5 230V 3000K





2008 è una piantana dalla linea semplice e minimale, idonea in tutti quegli ambienti moderni dove si desidera un'illuminazione diffusa e morbida. Ideale in soggiorni, sale da attesa, hall di alberghi, uffici di rappresentanza, spazi abitativi e spazi comuni.

Disponibile nella finitura bianco e in alluminio.

Caratteristiche tecniche:

Corpo in acciaio.

Diffusore in vetro con un portalampada universale R7s.

Sorgente a corredo new halo 120W e led 8W.

2008 is a floor lamp with simple and minimal appeal, it fits in all those modern environments where you want a diffused and soft lighting. Ideal for living rooms, waiting rooms, hotel lobbies, offices, living spaces and common areas.

Available in white finish and aluminum.

Technical features:

Steel body.

Glass diffuser with a universal R7s lampholder.

Includes: 120W New Halo.

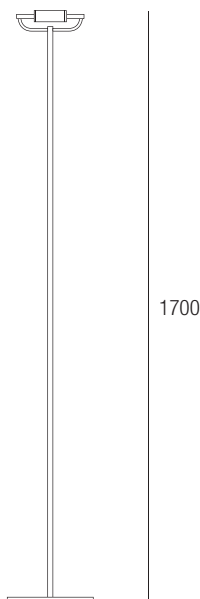

2008

Codice	Code	Euro
208/P1BIA	S+L	551,20
208/P1ALL	S+L	551,20

Materiali *Body*

Bianco (WH)
White (WH)

Alluminio (AA)
Aluminium (AA)

Peso *Weight*
5,1 Kg

Fonti luminose *Light source*



120W R7S 230÷240V 50Hz

New HALO **120W** =  **200W** classic





2009 è una piantana dalla linea semplice e minimale, idonea in tutti quegli ambienti moderni dove si desidera un'illuminazione diffusa e morbida. Ideale in soggiorni, sale da attesa, hall di alberghi, uffici di rappresentanza, spazi abitativi e spazi comuni. Disponibile nella finitura Bianco e Alluminio. Il diffusore in vetro è di forma ellittica orientabile.

Caratteristiche tecniche:

Corpo in acciaio.
Diffusore in vetro con un portalampada universale R7s.
Sorgente a corredo new halo 120W e led 8W.

2009 is a floor lamp with simple and minimal appeal, it fits in all those modern environments where you want a diffused and soft lighting. Ideal for living rooms, waiting rooms, hotel lobbies, offices, living spaces and common areas. Available in white finish and aluminum. The glass diffuser is adjustable and elliptical.

Technical features:

Steel body.
Glass diffuser with a universal R7s lampholder.
Includes: 120W New Halo.

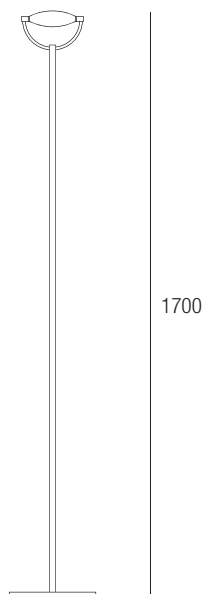
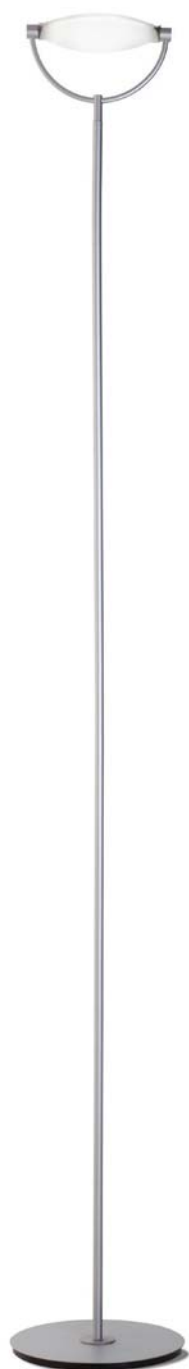

2009

Codice	Code	Euro
209/P1BIA	S+L	594,10
209/P1ALL	S+L	594,10

Materiali Body



Bianco (WH)
White (WH)



Alluminio (AA)
Aluminium (AA)

Peso Weight

5,1 Kg

Fonti luminose Light source



120W R7S 230÷240V 50Hz

New HALO **120W** =  **200W** classic





2010 è una piantana dalla linea semplice e minimale, idonea in tutti quegli ambienti moderni dove si desidera un'illuminazione diffusa e morbida. Ideali in soggiorni, sale da attesa, hall di alberghi, uffici di rappresentanza, spazi abitativi e spazi comuni. E' una lampada molto versatile e funzionale dotata di snodo che permette di orientare il flusso luminoso. Inoltre, sul corpo, è posizionata una luce da lettura con braccio flessibile perfetta, quindi, vicino a divani e poltrone. Disponibile nella finitura Bianco e Alluminio.

Caratteristiche tecniche:

Corpo in acciaio.

Diffusore in vetro con un portalampada universale R7s.

Sorgente a corredo new halo 120W e led 8W.

2010 is a floor lamp with simple and minimal appeal, it fits in all those modern environments where you want a diffused and soft lighting. Ideal for living rooms, waiting rooms, hotel lobbies, offices, living spaces and common areas. It's a versatile and functional lamp with a joint that allows you to direct the light flow. In addition, there is a reading light with flexible arm positioned on the body and is perfect, in areas close to sofas and armchairs. Available in white finish and aluminum.

Technical features:

Steel body.

Glass diffuser with a universal R7s lampholder.

Includes: 120W New Halo and a 8W LED.

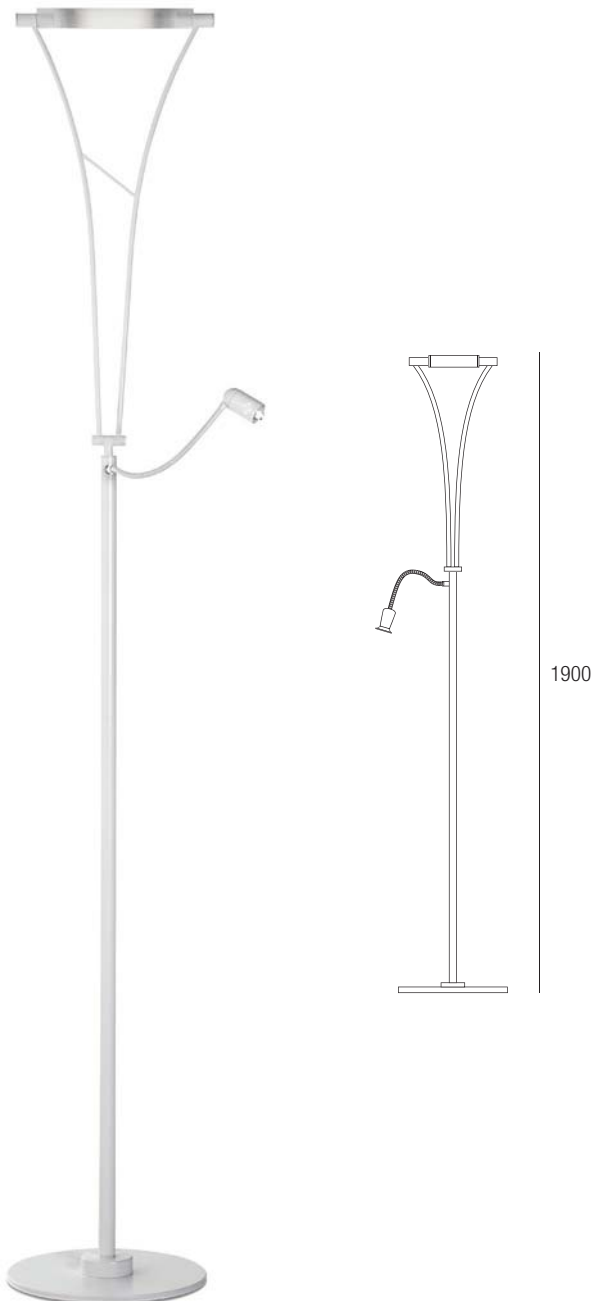

2010

Codice	Code	Euro
3350/P2BIA	S+L	708,50
3350/P2ALL	S+L	708,50

Materiali *Body*



Bianco (WH)
White (WH)



Alluminio (AA)
Aluminium (AA)

Peso *Weight*

5,1 Kg

Fonti luminose *Light source*



120W R7S 230÷240V 50Hz



2W LED G9



>30.000 h.

New HALO **120W** =  **200W** classic

LED **2W** =  **25W** classic







E INOLTRE...



AND ALSO...

da 214 a 241
from to

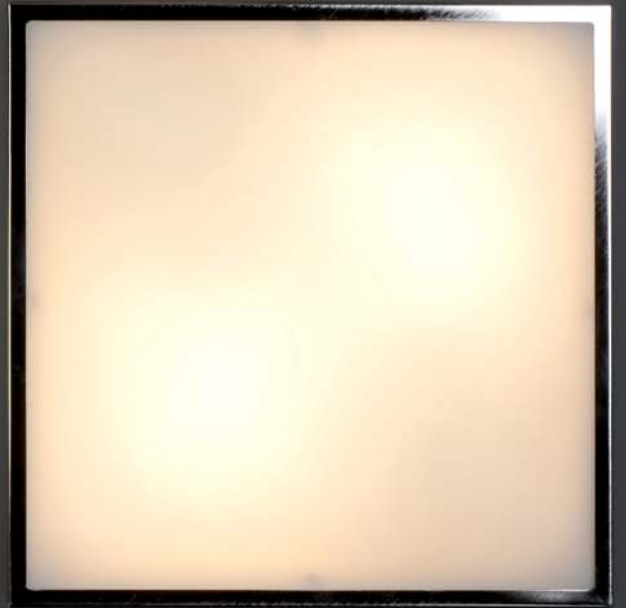
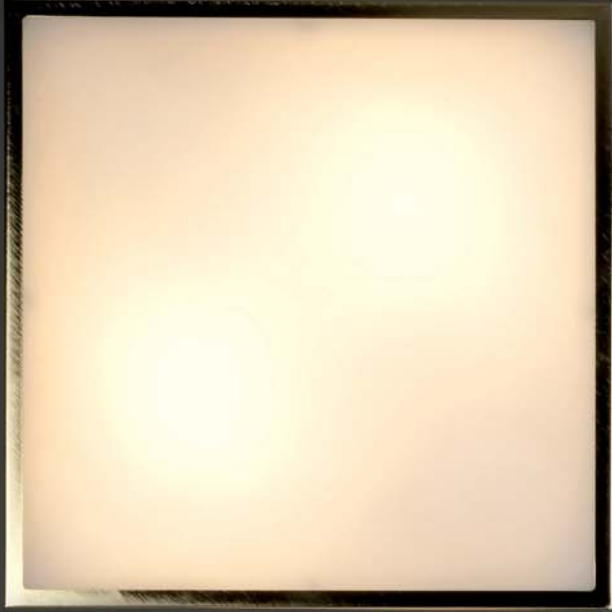

CAMELIA è una lampada dal design semplice, di forma quadrata, disponibile in due misure da 31 e da 41 cm. Emette una luce diffusa, uniforme, frontale a 180° e con un indice di resa cromatica elevato.

Molto adatta in ambienti abitativi e residenziali

Disponibile in due finiture, oro e cromo in galvanica così da adattarsi a diversi stili.

Caratteristiche tecniche:

Corpo in lamiera di acciaio

Schermo in vetro opale

Portalamпада in materiale termoplastico

Cablaggio completo di morsettiera

Attacco a parete in acciaio verniciato bianco a polvere dove sono posizionati i portalamпада (Gruppo Relco), la connessione elettrica e meccanica per l'attacco a parete.

CAMELIA is a square lamp featuring a simple design, available in two sizes, 31 and 41 cm. It provides diffused, uniform light over 180°, from the front, with a high colour rendering index.

It is very well-suited to living and residential spaces

It is available in two finishes, gold and galvanic chrome, so that it can adapt to different styles.

Technical features:

Sheet steel body

Opal glass screen

Thermoplastic lamp-holder

Wiring with terminal board

White powder painted steel wall fixture with lamp holder (Relco Group), electrical and mechanical connections are located for wall-installation.



CAMELIA 1

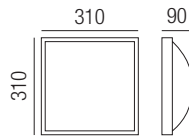

CAMELIA 1

Codice	Code	Euro
1229/1NIK	S (CR)	103,74
1229/1ORO	S (GD)	103,74

Materiali Body



1229/1NIK
Cromo (CR)
Chrome (CR)



1229/1ORO
Oro (GD)
Gold (GD)

Peso Weight

0,5 Kg

Fonti luminose Light source



max 60W E27 220÷240V 50Hz

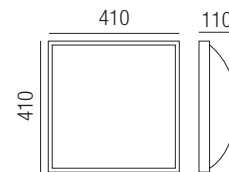

CAMELIA 2

Codice	Code	Euro
1229/2NIK	S (CR)	137,87
1229/2ORO	S (GD)	137,87

Materiali Body



1229/2NIK
Cromo (CR)
Chrome (CR)



1229/2ORO
Oro (GD)
Gold (GD)

Peso Weight

0,5 Kg

Fonti luminose Light source



max 2x60W E27 220÷240V 50Hz



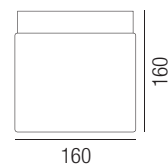

KUBIK SOFFITTO 1

Codice *Code* Euro
1004/1PM S 140,60

Materiali *Body*



Alluminio (AA)
Aluminium (AA)

Peso *Weight*
0,3 Kg

Fonti luminose *Light source*



max 40W E14 230-240V 50Hz





Kubik è una serie di lampade semplici, moderne, dalla forma geometrica. Molto luminose e versatili sono disponibili in diversi modelli: da soffitto, da parete e da tavolo. La luce emessa è calda e diffusa.

Le lampade Kubik sono quindi idonee ad illuminare tutti gli spazi moderni, abitazioni, reception, uffici, in ambito domestico e contract.

Caratteristiche tecniche:

Corpo in acciaio galvanizzato, finitura silver.

Diffusore in vetro opale.

Portalamпада universale E14.

Cablaggio completo di morsetti a 3 poli (Kubik Soffitto), cavo con spina e interruttore (Kubik Tavolo)

Kubik is a series of simple, modern lamps with a geometric shape. Providing a large amount of light and versatility, they are available in different models: ceiling, wall and table. They emit warm, diffused light.

Kubik lamps are therefore suitable for the lighting of any modern space, home, reception area and office in residential and contract environments.

Technical features:

Galvanised steel body with silver finish.

Opal glass shade.

E14 universal lamp holder.

Wiring with 3-pole terminal board (Kubik Ceiling), wire with plug and switch (Kubik Table)

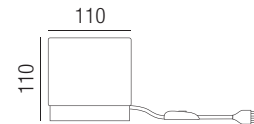
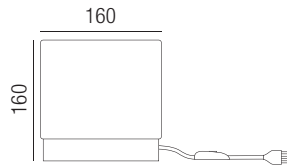
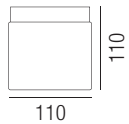

KUBIK SOFFITTO 2

Codice *Code* Euro
1004/1PP S 99,65

Materiali *Body*

 Alluminio (AA)
Aluminium (AA)

Peso *Weight*
0,2 Kg

Fonti luminose *Light source*



max 40W E14 230-240V 50Hz

KUBIK TAVOLO 1

Codice *Code* Euro
1004/L1M S 137,87

Materiali *Body*

 Alluminio (AA)
Aluminium (AA)

Peso *Weight*
0,3 Kg

Fonti luminose *Light source*



max 40W E14 230-240V 50Hz

KUBIK TAVOLO 2

Codice *Code* Euro
1004/L1P S 101,01

Materiali *Body*

 Alluminio (AA)
Aluminium (AA)

Peso *Weight*
0,2 Kg

Fonti luminose *Light source*



max 40W E14 230-240V 50Hz





Primula è una lampada da parete dal design semplice e lineare che ben si adatta a tutti gli ambienti. Ideale come sopraspecchio può essere utilizzata ovunque si desideri una luce discreta, calda e diffusa.

Caratteristiche tecniche:

Corpo in acciaio cromato
Schermo in vetro cristallo trasparente
Morsetteria e sorgenti inclusi

Primula is a wall lamp with simple, straightforward design that is well suited to all environments. Ideal as a mirror-light can be also used anywhere you would like a discreet light, warm and diffused.

Technical features:

Chrome plated steel body
Clear glass screen
Terminal blocks and springs included

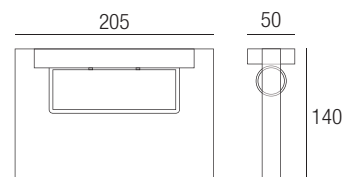

PRIMULA 1

Codice	Code	Euro
4014/1	S + L	185,64

Materiali *Body*



Cromo (CR)
Chrome (CR)

Peso *Weight*

0,5 Kg

Fonti luminose *Light source*



max 100W R7s 230÷240V 50Hz





HALO

Cod. 444056.0101 - 2700K



Lampada Leuci Halo GLS 70W - E27 intercambiabile con la classica lampada incandescente
Halo GLS Leuci lamp with 70W - E27 interchangeable with the standard lamp

FLUO

Cod. 600340.0101 - 2700K



Lampada Leuci Fluotronic 21W - E27 intercambiabile con la classica lampada incandescente
Fluotronic Leuci lamp with 21W - E27 interchangeable with the standard lamp

Cod. 600350.0101 - 2700K



Lampada Leuci Fluotronic 25W - E27 intercambiabile con la classica lampada incandescente
Fluotronic Leuci lamp with 25W - E27 interchangeable with the standard lamp

LED

Cod. 555130.0101 - 3000K



Lampada Leuci LED 16W - E27 intercambiabile con la classica lampada incandescente
LED Leuci lamp with 16W - E27 interchangeable with the standard lamp

Ego è una lampada da soffitto e da parete, semplice e moderno, dal design piacevole. Emette una luce diffusa ed è adatto agli ambienti domestici e per illuminare corridoio e sale di attesa. E' disponibile in due misure (diametro 15cm e diametro 24cm) e in quattro finiture: bianco, silver, nero e cromo.

Caratteristiche tecniche:

- Corpo in acciaio inox spazzolato con cromatura satinata
- Verniciatura di tipo poliestere, eseguita a polvere.
- Schermo in vetro opale.
- Portalampada in ceramica.
- Cablaggio completo di morsettiera.
- Sorgente Leuci abbinabili 70W ad alogeni o 2W1 o 25W a fluorescenza o 16W a LED.

Ego is a simple and modern ceiling and wall lamp, with an appealing design. It provides diffused light and is suitable for the home and the lighting in corridors and waiting rooms. It is available in two sizes (15cm diameter and 24 cm diameter) and in four finishes: white, silver, black and chrome.

Technical features:

- Body made with brushed stainless steel with satin-finish chrome-plating.
- Painting: powder polyester coating.
- Opal glass screen.
- Ceramic lamp holder.
- Wiring with terminal board.
- Leuci source that can mount 70W halogen bulbs or 2W1 or 25W fluorescent bulbs or 16W LED bulbs.

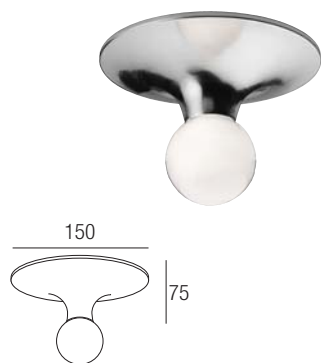

EGO 15

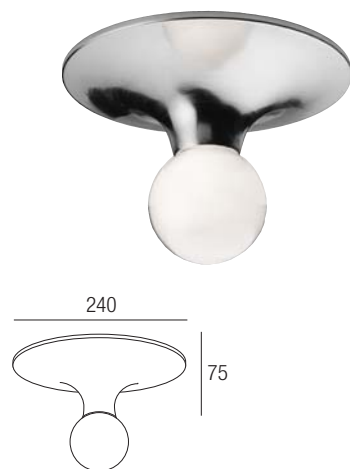

EGO 25

EGO 15

Codice	Code	Euro
32200	S (WH)	16,38
32201	S (AG)	16,38
32202	S (BK)	18,73
32204	S (CR)	19,11

Materiali Body

 **32200**
Bianco (WH)
White (WH)

 **32201**
Argento (AG)
Silver (AG)

 **32202**
Nero (BK)
Black (BK)

 **32204**
Cromo (CR)
Chrome (CR)

Peso Weight
0,15 Kg

Fonti luminose Light source

E27 230÷240V 50Hz

EGO 25

Codice	Code	Euro
32210	S (WH)	17,75
32211	S (AG)	17,75
32212	S (BK)	17,75
32214	S (CR)	28,67

Materiali Body

 **32210**
Bianco (WH)
White (WH)

 **32211**
Argento (AG)
Silver (AG)

 **32212**
Nero (BK)
Black (BK)

 **32214**
Cromo (CR)
Chrome (CR)

Peso Weight
0,25 Kg

Fonti luminose Light source

E27 230÷240V 50Hz

LED MONACO

Relcogroup engineering

Parete | Wall



LED MONACO è un faretto a led da parete orientabile, con braccio snodato così da direzionare il fascio luminoso secondo le esigenze. E' una lampada da interni, adatto nelle imbarcazioni, come testaletto e per creare effetti luminosi accentuati e decorativi anche in musei e gallerie d'arte.

Caratteristiche tecniche:

Corpo in alluminio satinato.

Diffusore in vetro satinato e lente in acrilico trasparente prismaticizzata.

Sorgente Led Leuci di potenza bianco 3000K.

Alimentazione inclusa, completo di interruttore.

LMONACO LED is a direction-adjustable wall spotlight, with an articulated arm to direct the beam of light as needed. It is a lamp for interiors, suitable for use on headboards in ships and to create accent and decorative lighting in museums and art galleries.

Technical features:

Satin-finish aluminium body.

Satin-finish glass shade and prismaticised transparent acrylic lens.

3,000K white power Leuci Led source.

Power supply included, with switch.

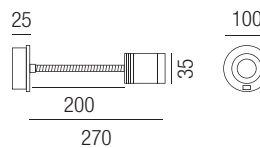

LED MONACO LED 3

Codice	Code	Euro
27258	CELL	51,87

Materiali *Body*



Alluminio (AA)
Aluminium (AA)

Peso *Weight*

0,5 Kg

Fonti luminose *Light source*

 **>30.000 h.**
3Wx1 LED 230V 50Hz 3000K

LED **1W** =  **6W HALO**

    **IP20**



Morrison è una lampada da parete decorativa per interni ideale per illuminare quadri, stampe, fotografie ed immagini. Studiata per musei, gallerie d'arte e spazi pubblici ben si presta anche da un uso abitativo per dare valore ad opere d'arte e componenti d'arredo. La luce emessa è calda e direzionata verso il basso, non produce abbagliamento. Disponibile in tre finiture: Bianca, Oro e Cromo.

Caratteristiche tecniche:

Corpo in acciaio regolabile con 2 portalampada universale E14.
Sorgente Leuci ad alogeni e la luminosità regolabile con un semplice potenziometro.
Portalampada in ceramica.
Cablaggio completo di morsettiera a 3 poli. Alimentazione inclusa.

Morrison is a decorative wall lamp for interiors, ideal for lighting pictures, prints, photos and images. It is designed for museums, art galleries and public areas, and is also well-suited for highlighting works of art and décor in living areas. It produces a warm light, directed downwards, without any glare. Available in three finishes: White, Gold and Chrome.

Technical features:

*Adjustable steel body with 2 E14 universal lamp holders.
Halogen Leuci source and adjustable light intensity with a simple potentiometer.
Ceramic lamp holder.
Wiring with 3-pole terminal board. Power supply included.*

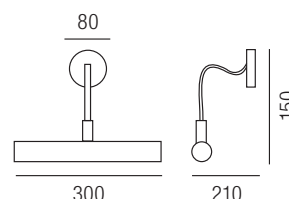

MORRISON

Codice	Code	Euro
30510	S	36,86
30512	S	38,22
30514	S	38,22

Materiali *Body*

 **30510**
Bianco (WH)
White (WH)

 **30512**
Oro (GD)
Gold (GD)

 **30514**
Cromo (CR)
Chrome (CR)

Peso *Weight*
0,5 Kg

Fonti luminose *Light source*



max 2x40W E14 230V 50Hz



LED BRERA - LED ZEDRA

Relcogroup engineering

LED BRERA e LED ZEDRA sono due lampade da parete in alluminio studiate appositamente per illuminare quadri, stampe, fotografie ed opere d'arte. La sorgente led le rende particolarmente efficaci in quanto la tecnologia led non scalda, né scolorisce gli oggetti illuminati, non emette raggi infrarossi e ultravioletti e, pertanto, assicura una migliore conservazione delle opere stesse.

Quest'apparecchio funzionale ed efficace è stato realizzato in tre diverse forme, con tre diverse potenze luminose e in due finiture: cromo e oro. LED BRERA ha una linea sfilata, moderna, sottile mentre LED ZEDRA, sia nella versione semplice che double, ha un profilo più classico.

Caratteristiche tecniche:

Corpo in alluminio spazzolato.

Diffusore in vetro satinato.

Fascio di emissione 120° (LED Brera).

Sorgente Led CITIZEN da 6W (LED Brera) - 9W (LED Zedra) - 18W (LED Zedra Double).

Alimentazione elettronica Relco inclusa.

BRERA LED and ZEDRA LED are two aluminium wall lamps designed specially to provide lighting for pictures, prints, photographs and works of art. The led source makes them particularly suited for this purpose, as led technology does not cause heating or fading of the objects under the light source, they do not produce infra-red and ultra-violet rays and, accordingly, allow better preservation of the works of art.

This functional and efficient fixture is available in three different shapes, three different light intensities and two finishes: chrome and gold.

BRERA LED has a taught, modern, slender line, while ZEDRA LED has a more classic profile, in both its simple and double versions.

Technical features:

Brushed aluminium body.

Stain-finish glass shade.

120° beam emission (Brera LED).

6W (Brera LED) - 9W (Zedra LED) - 18W (Zedra Double LED) CITIZEN Led source.

Relco electronic power supply (included).



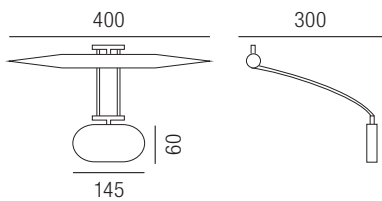

LED BRERA

Codice	Code	Euro
27270	CELL (AG)	200,66

Materiali *Body*

 **27270**
Argento (AG)
Silver (AG)

Peso *Weight*
0,7 Kg

Fonti luminose *Light source*



>30.000 h.

6W LED 230÷240V 50Hz 4000K lens 120°

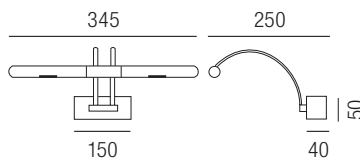

LED ZEDRA

Codice	Code	Euro
12124	CELL (CR)	257,40
12126	CELL (GD)	257,40

Materiali *Body*

 **12124**
Cromo (CR)
Chrome (CR)

 **12126**
Oro (GD)
Gold (GD)

Peso *Weight*
0,65 Kg

Fonti luminose *Light source*



>30.000 h.

9W LED 230÷240V 50Hz 3000K lens 120°

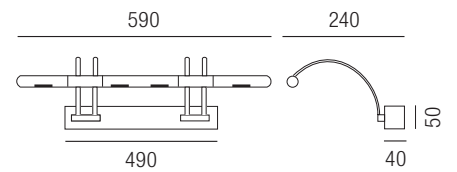

LED ZEDRA DOUBLE

Codice	Code	Euro
12128	CELL (CR)	468,00
12130	CELL (GD)	468,00

Materiali *Body*

 **12128**
Cromo (CR)
Chrome (CR)

 **12130**
Oro (GD)
Gold (GD)

Peso *Weight*
1,3 Kg

Fonti luminose *Light source*



>30.000 h.

18W LED 230÷240V 50Hz 3000K lens 120°

LED **6W** =  **25W HALO**



LED **9W** =  **50W HALO**



LED **18W** =  **70W HALO**



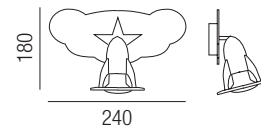

LSACE99/1

Codice	Code	Euro
LSACE99/1SIL	S	37,56

Colore *Colour*



Blu
Blue

Peso *Weight*

0,4 Kg

Fonti luminose *Light source*



max 40W E14-R50 230-240V 50Hz

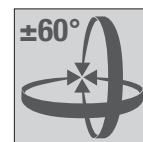

KIDS SPOT è una serie di faretti da soffitto e parete ideati per le camere dei bambini, in asili, scuole primarie e in tutti quegli ambiti dedicati all'infanzia. I colori accesi, le forme simpatiche e legate a temi infantili fanno di queste lampade un'alternativa originale. Disponibili in quattro varianti con uno, due o tre punti luce.

Caratteristiche tecniche:

Corpo in acciaio galvanizzato e legno.
 Ottica orientabile 360°.
 Portalampada termoplastico.
 Cablaggio completo di morsettiera a 3 poli.

KIDS SPOT is a series of ceiling and wall spotlights, designed for children's bedrooms, nursery schools, elementary schools and any space dedicated to child-care. The bright colours, the fun shapes connected to children's themes, make these lamps a unique alternative. Available in four variations with one, two or three lighting point.

Technical features:

Galvanised steel and wood body.
 360° direction-adjustable optic.
 Thermoplastic lamp holder.
 Wiring with 3-pole terminal board.

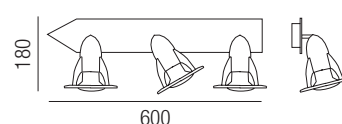
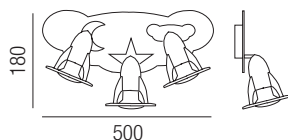
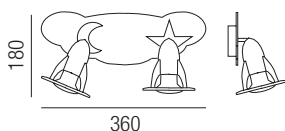

LSACE99/2

Codice Code Euro
LSACE99/2SIL S 65,87

Colore Colour



Blu
 Blue

Peso Weight
0,75 Kg

Fonti luminose Light source



max 2x40W E14-R50 230-240V 50Hz

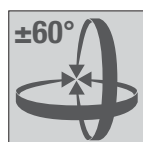

LSACE99/3

Codice Code Euro
LSACE99/3SIL S 73,27

Colore Colour



Giallo
 Yellow

Peso Weight
1,52 Kg

Fonti luminose Light source



max 3x40W E14-R50 230-240V 50Hz

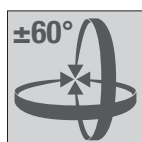

LSABE99/3

Codice Code Euro
LSABE99/3SIL S 64,16

Colore Colour



Rosso
 Red

Peso Weight
1,1 Kg

Fonti luminose Light source



max 3x40W E14-R50 230-240V 50Hz

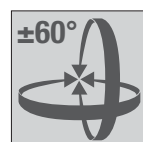



LED SPOT è una serie di lampade da parete o plafone a uno, due o tre punti luce. Dal design moderno, uniscono il concetto di spot orientabile alla tecnologia led. Emettono una luce calda e direzionale, a 4000K, ideale quindi sia in contesti abitativi che in uffici, spazi pubblici, sale d'attesa.

Caratteristiche tecniche:

Corpo in acciaio lucido.
Lampada Led 3W (SPOT1), 3Wx2 (SPOT2), 3Wx3 (SPOT 3).
Ottica orientabile a 360°.

SPOT LED is a series of wall or ceiling lamps with one, two or three lighting points. Featuring a modern design, they combine the concept of direction-adjustable spotlight with LED technology. They provide a warm and direction-adjustable light at 4000K, which is ideal for living areas, offices, public areas and waiting rooms.

Technical features:

Glossy steel body.
3W (SPOT1), 3Wx2 (SPOT2), 3Wx3 (SPOT 3) LED lamp.
360° direction-adjustable optic.

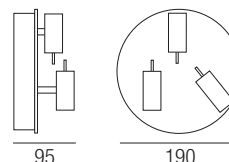
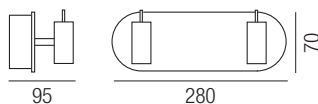
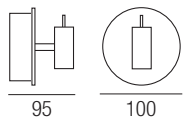

LED SPOT 1

Codice	Code	Euro
12168	CELL	50,51

Materiali *Body*



Cromo (CR)
Chrome (CR)

Peso *Weight*
0,28 Kg

Fonti luminose *Light source*



>30.000 h.

3W LED 100-240V 50/60Hz 4000K

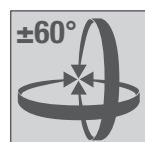

LED **3W** =  **20W HALO**



LED SPOT 2

Codice	Code	Euro
12169	CELL	95,55

Materiali *Body*



Cromo (CR)
Chrome (CR)

Peso *Weight*
0,56 Kg

Fonti luminose *Light source*



>30.000 h.

6W LED 100-240V 50/60Hz 4000K

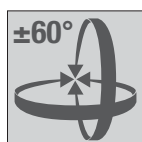

LED **3W** =  **20W HALO**



LED SPOT 3

Codice	Code	Euro
12170	CELL	125,58

Materiali *Body*



Cromo (CR)
Chrome (CR)

Peso *Weight*
0,92 Kg

Fonti luminose *Light source*



>30.000 h.

9W LED 100-240V 50/60Hz 4000K

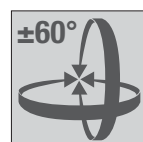

LED **3W** =  **20W HALO**



LED PERTH è un'utile e moderna lampada da tavolo dalla forma semplice ed essenziale ideale per scrivanie, piani da lavoro, tavolini e ovunque si desideri un fascio di luce discreto a bassissima emissione di calore. Disponibile in due finiture cromatiche, blu ed arancione, ha un braccio flessibile (con finitura cromata) che consente di puntare e orientare a piacimento il fascio luminoso.

Caratteristiche tecniche:

- Corpo in metallo e materiale termoplastico.
- Diffusore con gruppo ottico a fascio di emissione da 120°.
- Alimentazione elettronica a spina (inclusa), interruttore posizionato sulla base.
- Sorgente Led Leuci 3W, 4000K.

PERTH LED is a practical, modern table lamp with a simple and basic shape, ideal for desks, work tables, tables and anywhere you require a discrete beam of light with low heat emissions. It is available in two colour finishes, blue and orange, with a flexible arm (with chrome-plated finish) to point and direct the light beam as needed.

Technical features:

- Metal body and thermoplastic material.*
- Shade with 120° beam emission optic assembly.*
- Electronic power supply with plug (included), switch on the base.*
- 3W, 4000K Leuci LED source.*

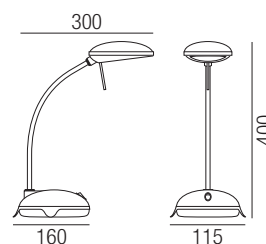
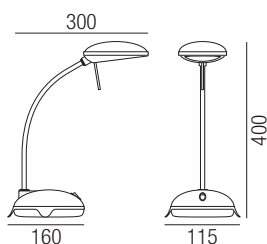

LED PERTH

Codice Code Euro
27204 CELL 37,70

Colore Colour



Arancione
 Orange

Peso Weight

1,0 Kg

Fonti luminose Light source



>30.000 h.

3W LED 100-240V 50/60Hz 4000K

LED PERTH

Codice Code Euro
27205 CELL 37,70

Colore Colour



Blu
 Blue

Peso Weight

1,0 Kg

Fonti luminose Light source



>30.000 h.

3W LED 100-240V 50/60Hz 4000K

LED **3W** =  **6W HALO**



LED **3W** =  **6W HALO**



LED SIDNEY è una lampada da tavolo ideale per scrivanie, piani di lavoro, tavolini e ovunque sia necessario proiettare un fascio di luce discreto a bassissima emissione di calore. Disponibile in tre finiture cromatiche, argento blu ed arancione che ne definiscono la base d'appoggio è dotata di un braccio flessibile (con finitura cromata) che consente l'orientamento del fascio luminoso.

Caratteristiche tecniche:

Corpo in metallo e materiale termoplastico.
 Diffusore con gruppo ottico a fascio di emissione da 120°.
 Alimentazione elettronica a spina (inclusa), interruttore posizionato sulla base.
 Sorgente Led Leuci 2,4W, 4000K.

SYDNEY LED is the ideal table lamp for desks, work tables, tables and anywhere you require a discrete beam of light with low heat emissions. The base is available in three colour finishes, silver, blue and orange, and it is fitted with a flexible arm (with chrome-plated finish), to direct the beam of light.

Technical features:

Metal body and thermoplastic material.
 Shade with 120° beam emission optic assembly.
 Electronic power supply with plug (included), switch on the base.
 2.4W, 4000K Leuci LED source.



LED SYDNEY

Codice Code Euro
27273 CELL 39,59

Colore Colour



Argento
 Silver

Peso Weight

1,0 Kg

Fonti luminose Light source



>30.000 h.

2,4W LED 100-240V 50/60Hz 4000K



LED SYDNEY

Codice Code Euro
27274 CELL 39,59

Colore Colour



Arancione
 Orange

Peso Weight

1,0 Kg

Fonti luminose Light source



>30.000 h.

2,4W LED 100-240V 50/60Hz 4000K



LED SYDNEY

Codice Code Euro
27275 CELL 39,59

Colore Colour



Blu
 Blue

Peso Weight

1,0 Kg

Fonti luminose Light source



>30.000 h.

2,4W LED 100-240V 50/60Hz 4000K

LED **2,4W** =  **6W HALO**



LED **2,4W** =  **6W HALO**



LED **2,4W** =  **6W HALO**



LED AUSTRALIA è una lampada da tavolo ideale per scrivanie, piani di lavoro, tavolini e ovunque sia necessario proiettare un fascio di luce discreto a bassissima emissione di calore. Disponibile in due finiture cromatiche, argento o nero che ne definiscono parzialmente la base d'appoggio e l'alloggiamento della sorgente; un doppio braccio rigido (anch'esso con finitura cromata) consente un parziale puntamento del fascio luminoso.

Caratteristiche tecniche:

- Corpo in metallo e materiale termoplastico
- Diffusore con gruppo ottico a fascio di emissione da 120°
- Alimentazione elettronica a spina (inclusa), interruttore posizionato sulla base
- Sorgente Led Leuci 3W, 4000K

AUSTRALIA LED is the ideal table lamp for desks, work tables, tables and anywhere you require a discrete beam of light with low heat emissions. Available in two colour finishes, silver or black, which partially define the base and source enclosure; a double rigid arm (also with chrome-plate finish) is used to partially direct the beam of light.

Technical features:

- Metal body and thermoplastic material
- Shade with 120° beam emission optic assembly
- Electronic power supply with plug (included), switch on the base
- 3W, 4000K Leuci LED source

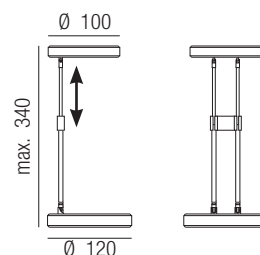
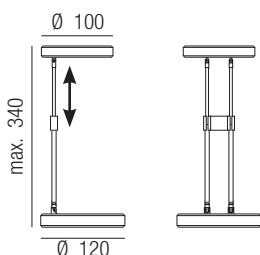

LED AUSTRALIA

Codice Code Euro
27320 CELL 35,75

Colore Colour

 Argento - Cromo
 Silver - Chrome

Peso Weight
1,0 Kg

Fonti luminose Light source

  **>30.000 h.**
 3W LED 100-240V 50/60Hz 4000K

LED AUSTRALIA

Codice Code Euro
27321 CELL 35,75

Colore Colour

 Nero - Cromo
 Black - Chrome

Peso Weight
1,0 Kg

Fonti luminose Light source

  **>30.000 h.**
 3W LED 100-240V 50/60Hz 4000K

LED **3W** =  **6W HALO**

    **IP20**

LED **3W** =  **6W HALO**

    **IP20**

LED MELBOURNE è una lampada da tavolo ideale per scrivanie, piani di lavoro, tavolini e ovunque sia necessario proiettare un fascio di luce discreto a bassissima emissione di calore. Dal design minimale e dalla forma essenziale, ben si adatta a tutti gli ambienti e stili. E' disponibile in un'unica finitura cromatica di colore grigio; il braccio flessibile consente in modo semplice ma efficace di direzionare il fascio luminoso.

Caratteristiche tecniche:

Corpo in metallo e materiale termoplastico.
 Diffusore con gruppo ottico a fascio di emissione da 120°.
 Alimentazione elettronica a spina (inclusa), interruttore posizionato sulla base.
 Sorgente Led Leuci 3W, 4000K.

MELBOURNE LED is the ideal table lamp for desks, work tables, tables and anywhere you require a discrete beam of light with low heat emissions. Featuring a minimal design and basic shape, it adapts well to any setting and style. It is only available in grey; the flexible arm makes it possible to direct the beam of light easily and effectively.

Technical features:

*Metal body and thermoplastic material.
 Shade with 120° beam emission optic assembly.
 Electronic power supply with plug (included), switch on the base.
 3W, 4000K Leuci LED source.*

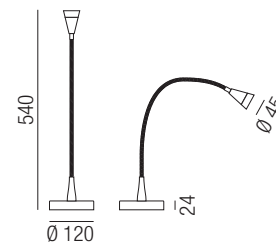

LED MELBOURNE

Codice *Code* Euro
27206 **CELL** **29,51**

Colore *Colour*

 Argento
 Silver

Peso *Weight*
1,0 Kg

Fonti luminose *Light source*
  **>30.000 h.**
 3W LED 100-240V 50/60Hz 4000K

LED **3W** =  **6W HALO**

    **IP20**

LED NASKA

Relcogroup engineering

Tavolo - Terra | Table - Floor



LED NASKA è una serie di lampade da tavolo (LED NASKA 1) e da terra (LED NASKA 2) dal design moderno, semplice e funzionale. Sia la versione da tavolo che quella da terra sono dotate di braccio snodato ideale per orientare il fascio luminoso. La sorgente led assicura una luce uniforme e una bassissima emissione di calore. E' disponibile in due finiture: bianco o nero.

Caratteristiche tecniche:

- Corpo in acciaio cromato
- Diffusore in metallo verniciato
- Base in metallo verniciato
- Alimentazione elettronica a spina (inclusa), interruttore posizionato sul diffusore
- Sorgente Led Leuci da 1,8W (Led Naska1) e da 3W (Led Naska 2), entrambe a 6000K.

NASKA LED is a series of table (NASKA LED 1) and floor (NASKA LED 2) lamps, featuring a modern, simple and functional design. Both the table and floor versions are equipped with an articulated arm, ideal for adjusting the direction of the beam of light. The source provides uniform light and very low heat emissions. It is available in two finishes: white or black.

Technical features:

- Chrome-plated steel body
- Painted metal shade
- Painted metal base
- Electronic power supply with plug (included), switch on the shade
- 1.8W (Naska 1 LED) and 3W (Naska 2 LED) Leuci LED source, both 6000K.

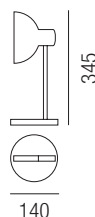

LED NASKA 1



Codice	Code	Euro
27294	CELL	47,78
27295	CELL	47,78

Colore Colour

27294
Bianco
White

27295
Nero
Black

Peso Weight
1,2 Kg

Fonti luminose Light source

 >30.000 h.
 1,8W LED 220-240V 50Hz 6000K

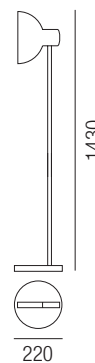
LED **1,8W** =  **12W HALO**
    **IP20**



LED NASKA 2

Codice	Code	Euro
27296	CELL	77,81
27297	CELL	77,81

Colore Colour

27296
Bianco
White

27297
Nero
Black

Peso Weight
2,5 Kg

Fonti luminose Light source

 >30.000 h.
 3W LED 220-240V 50Hz 6000K

LED **3W** =  **20W HALO**
    **IP20**



LED GRAZ è una semplice e funzionale lampada da tavolo con 1 LED MULTICHIP di segnalazione. I tre snodi presenti sul braccio permettono di orientare il fascio luminoso così da direzionarlo a seconda delle esigenze. La finitura è in nichel spazzolato adatta a tutti gli stili. Idonea per scrivanie, piani di lavoro, tavolini e ovunque serva una luce puntuale.

Caratteristiche tecniche:

- Corpo in nichel spazzolato.
- Gruppo ottico con un fascio di emissione da 120°.
- Cablaggio con interruttore sul cavo e alimentatore elettronico a spina (Relco).
- Sorgente Led Leuci 5W, 4000K

GRAZ LED is a simple and functional table lamp with 1 signalling MULTICHIP LED. The three joints on the arm make it possible to direct the beam of light as needed. The brushed nickel finish is suitable for any style. It is suitable for desks, work surfaces, tables and anywhere you need marked lighting.

Technical features:

- Brushed nickel body.
- Optic assembly with 120° beam emission.
- Wiring with switch on the cable and electronic power supply unit with plug (Relco).
- 5W, 4000K Leuci LED source



LED GRAZ

Codice	Code	Euro
27272	CELL	103,74

Colore Colour

Argento
Silver

Peso Weight

4,0 Kg

Fonti luminose Light source



>30.000 h.

5W LED 230V 50Hz 4000K

LED **3W** =  **6W HALO**

     **IP20**

1410

Relcogroup engineering

Terra | Floor



PIANTANA 1410, è una lampada da terra decorativa ideale per illuminare in modo discreto ed efficace ambienti conviviali, soggiorni, sale da attesa, hall di alberghi. La particolarità di essere dotata anche di una luce da lettura orientabile la rende molto adatta anche per essere posizionata vicino a divani e poltrone. Disponibile nella finitura Silver.

Caratteristiche tecniche:

Corpo in acciaio galvanizzato.

Diffusori in materiale plastico con 2 portalampana universali E27 + E14.

Portalampana in materiale termoplastico.

Cablaggio completo di cavo, spina e interruttore.

Sorgente Leuci Halo da 60W e 40W.

1410 FLOOR LAMP is a decorative floor lamp, ideal for lighting cosy spaces, living rooms, waiting rooms and hotel halls, discretely and efficiently. It also features a direction-adjustable reading light that makes it very suitable for installation next to sofas and armchairs. Available with a Silver finish.

Technical features:

Galvanised steel body.

Plastic shades with 2 E27 + E14 universal lamp holders.

Thermoplastic screen.

Thermoplastic lamp holder.

Wiring complete with cable, plug and switch.

60W and 40W Halo Leuci source.

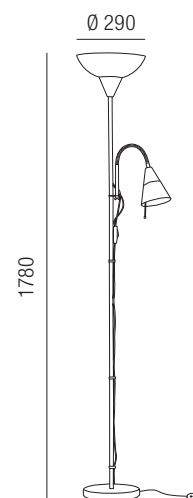

1410

Codice *Code*
1410BLASIL S Euro **65,52**

Colore *Colour*



Argento
Silver

Peso *Weight*

5,5 Kg

Fonti luminose *Light source*



60W E27 230-240V 50Hz



40W E14 230-240V 50Hz



lighting technologies

PIANTANA 2005 è una lampada da terra decorativa ideale per ambienti dove è necessaria un'illuminazione diffusa e morbida. Consigliata in soggiorni, sale da attesa, hall di alberghi, uffici di rappresentanza, camere da letto. E' dotata di dimmer per la regolazione dell'intensità luminosa. Disponibile nelle finiture Silver e Antracite.

Caratteristiche tecniche:

- Corpo in acciaio verniciato.
- Diffusore in vetro con un portalampada universale R7s.
- Portalampada in ceramica.
- Cablaggio completo di cavo, spina e dimmer.

2005 FLOOR LAMP is a decorative floor lamp, ideal for spaces requiring diffused and soft lighting. Recommended for living rooms, waiting rooms, hotel halls, representative offices, bedrooms. It is equipped with a dimmer to adjust the light intensity. Available in Silver and Anthracite finishes.

Technical features:

- Painted steel body.
- Glass shade with R7s universal lamp holder.
- Ceramic lamp holder.
- Wiring complete with cable, plug and dimmer.

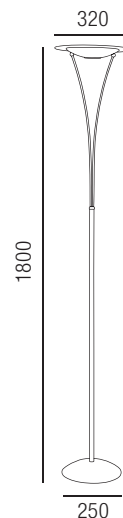

2005

Codice	Code	Euro
2005SIL	S	139,23
2005NKS	S	161,07

Colore Colour

 **2005SIL**
Argento
Silver

 **2005NKS**
Alluminio
Aluminium

Peso Weight

6,0 Kg

Fonti luminose Light source



150W R7s 230-240V 50Hz 3000K



PIANTANA 2007 è una lampada da terra moderna e funzionale dotata di tre spot direzionali e orientabili. La struttura semplice in acciaio la rende adatta a tutti gli stili. Ideale per uso abitativo, per uffici e aree comuni. La sorgente a LED genera una luce calda e armoniosa con una bassissima emissione di calore.

Caratteristiche tecniche:

Corpo in acciaio galvanizzato.

Portalamпада in ceramica.

Cablaggio completo di cavo, spina e interruttore.

Sorgente Led Leuci a 3000K.

2007 FLOOR LAMP is a modern and functional floor lamp equipped with three direction-adjustable spotlights. Its simple steel structure makes it suitable for any style. Suitable for the home, offices and common areas. The LED source provides a warm and harmonious light and very low heat emissions.

Technical features:

Galvanised steel body.

Ceramic lamp holder.

Wiring complete with cable, plug and switch.

3,000K Leuci LED source.

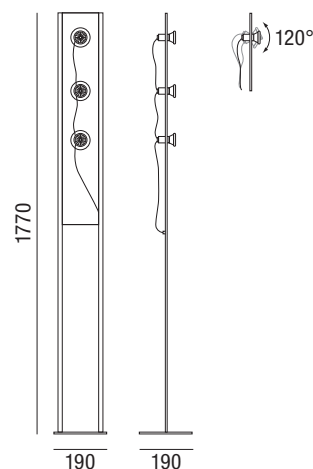

2007

Codice	Code	Euro
2007/NKS	S	222,50

Colore Colour



Argento
Silver

Peso Weight

6,5 Kg

Fonti luminose Light source



3x50W GU10 230-240V 50Hz 3000K



PIANTANA 2742D è una lampada da terra decorativa in stile arte povera, ideale per ambienti dallo stile classico dove è necessaria un'illuminazione diffusa e morbida. Studiata per uso abitativo può essere però posizionata anche in sale da attesa, hall di alberghi, uffici. E' dotata di dimmer per la regolazione dell'intensità luminosa. Disponibile nella finitura Ruggine.

Caratteristiche tecniche:

- Corpo in acciaio verniciato.
- Diffusore in vetro con un portalampada universale E27.
- Schermo in vetro opale.
- Portalampada in materiale termoplastico.
- Cablaggio completo di cavo, spina e dimmer.

2742D FLOOR LAMP is a decorative floor lamp in the arte povera style, ideal for spaces with a classic style requiring diffused and soft lighting. Designed for living spaces, it can also be installed in waiting rooms, hotel halls and offices. It is equipped with a dimmer to adjust the light intensity. Available with a Rust finish.

Technical features:

- Painted steel body.
- Glass shade with E27 universal lamp holder.
- Opal glass screen.
- Thermoplastic lamp holder.
- Wiring complete with cable, plug and dimmer.

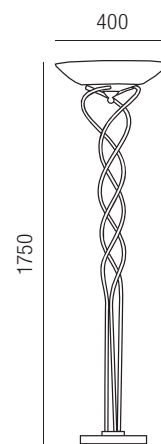

2742D

Codice	Code	Euro
2742D/RUG	S	174,72

Colore Colour



Ruggine
Rust

Peso Weight

11 Kg

Fonti luminose Light source



max 150W E27 230-240V 50Hz



FORMA LED MOOD
LURA TRE LED
FERA LED TRIBECA CT
GLASS DADO MINI W



INDICE Segno

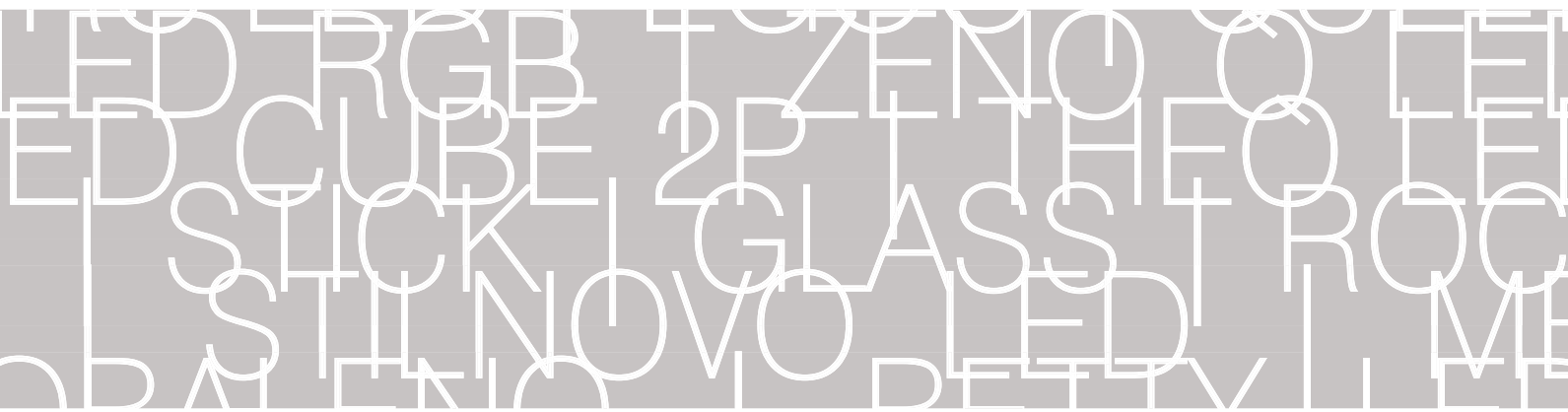

Segno INDEX

Indice | Indice

Indice in ordine di articolo | Index according to article name

articolo article	codice code	pagina page	articolo article	codice code	pagina page
1410	1410BLASIL	238	GIACINTO 1 - ARG	4012/2	163
2005	2005SIL	239	GIACINTO 1 - WH	4010/50	162
2005	2005NKS	239	GIACINTO 2 - ARG	4011/1	163
2007	2007/NKS	240	GIACINTO 2 - WH	4010/40	162
2008	208/P1BIA	209	GIACINTO 3 - ARG	4010/1	163
2008	208/P1ALL	209	GIACINTO 3 - WH	4010/30	162
2009	209/P1BIA	211			
2009	209/P1ALL	211	HALO GLOBO 70W	444056.0101	82-222
2010	3350/P2BIA	213			
2010	3350/P2ALL	213	KUBIK SOFFITTO 1	1004/1PM	218
2742D	2742D/RUG	241	KUBIK SOFFITTO 2	1004/1PP	219
			KUBIK TAVOLO 1	1004/L1M	219
			KUBIK TAVOLO 2	1004/L1P	219
ASTER - LED ASTER	32351	133			
ASTER - LED ASTER	32351/LED	133	LED ARCO	32181/LED	176
ASTER - LED ASTER	32353	133	LED ARCO	32182/LED	176
ASTER - LED ASTER	32353/LED	133	LED ARCO	32183/LED	176
ASTER - LED ASTER	32355	133	LED AURA 15 - BK	800201	56
ASTER - LED ASTER	32355/LED	133	LED AURA 15 - GR	800126	56
AURA CEILING ROSE 100W	805026	57	LED AURA 15 - RD	800203	56
AURA CEILING ROSE 50W	805126	57	LED AURA 15 - WH	800202	56
AURA CONTROSOFFITTO PLATE	805226	57	LED AURA 6 - BK	800001	56
			LED AURA 6 - GR	800226	56
BABY	150004	137	LED AURA 6 - RD	800003	56
BABY BULB	155000	137	LED AURA 6 - WH	800002	56
BABY ELECTRIC BOX	155100	137	LED AURA 9 - BK	800101	56
			LED AURA 9 - GR	800026	56
CAMELIA 1	1229/1NIK	217	LED AURA 9 - RD	800103	56
CAMELIA 1	1229/1ORO	217	LED AURA 9 - WH	800102	56
CAMELIA 2	1229/2NIK	217	LED AURA COMP - Double Emission	801802	59
CAMELIA 2	1229/2ORO	217	LED AURA COMP - Double Emission	801801	59
			LED AURA COMP - Double Emission	801817	59
EGO 15	32200	223	LED AURA COMP - Double Emission	801803	59
EGO 15	32201	223	LED AURA COMP - Single Emission	802002	59
EGO 15	32202	223	LED AURA COMP - Single Emission	802001	59
EGO 15	32204	223	LED AURA COMP - Single Emission	802017	59
EGO 25	32210	223	LED AURA COMP - Single Emission	802003	59
EGO 25	32211	223	LED AUSTRALIA	27320	234
EGO 25	32212	223	LED AUSTRALIA	27321	234
EGO 25	32214	223	LED AXOLUTE W MINI	32388	135
			LED AXOLUTE W MINI	32384	135
FAHB	310100	37	LED BETTY	27299	31
FLEXA ABAT-JOUR	505002	106	LED BETTY	27298	31
FLEXA ABAT-JOUR	505000	106	LED BETTY	27300	31
FLEXA ABAT-JOUR	505001	106	LED BOX 120	510202/LED	141
FLEXA ABAT-JOUR	505040	107	LED BOX 120	510217/LED	141
FLEXA ABAT-JOUR	505041	107	LED BOX 60	510002/LED	141
FLEXA ABAT-JOUR	505003	107	LED BOX 60	510017/LED	141
FLEXA CEILING ROSE	505119	99-101	LED BOX 90	510102/LED	141
			LED BOX 90	510117/LED	141
GEMINI GLOBO 21W	600340.0101	82-222	LED BRERA	27270	227
GEMINI GLOBO 25W	600350.0101	82-222			

Indice | Indice

Indice in ordine di articolo | Index according to article name

articolo article	codice code	pagina page	articolo article	codice code	pagina page
LED CONCA	32171/LED	177	LED GLASS	190419	166
LED CONCA	32172/LED	177	LED GLASS 25	191104	167
LED CONCA	32173/LED	177	LED GLASS 25	191119	167
LED CORALLO APPLIQUE	2276/A-1/LED	88	LED GLASS G	190604	166
LED CORALLO PIANTANA	2276/LED	89	LED GLASS G	190619	166
LED CORALLO SOSPENSIONE	2276/S-1/LED	90	LED GLASS G 25	191204	167
LED CORALLO TAVOLO	2276/L-1/LED	91	LED GLASS G 25	191219	167
LED CUBE 1G	88/A1	179	LED GLOBO 16W	555130.0101	82-222
LED CUBE 2P	103/A1	181	LED GOLF	830102	169
LED DADO MINI C	210217/LED	145	LED GOLF	830002	169
LED DADO MINI W	210317/LED	145	LED GOLF	830101	169
LED DADO MINI W DOUBLE	210417/LED	143	LED GOLF	830001	169
LED DADO W 60	210017/LED	143	LED GOLF RC	830302	171
LED DISKO	30835	35	LED GOLF RC	830202	171
LED DISKO MOBILE BATTERY	30837	35	LED GOLF RC	830301	171
LED DISKO PLUS	30836	35	LED GOLF RC	830201	171
LED EGOO C	440115/LED	149	LED GRAZ	27272	237
LED EGOO OUTDOOR IP44	440315/LED	149	LED L'ARCOBALENO F	270100	173
LED EGOO W	440215/LED	149	LED L'ARCOBALENO W	270200	173
LED EQUAL BIG	840102	153	LED LED	020100	39
LED EQUAL BIG	840002	153	LED LEON	13/A1BIA/LED	185
LED EQUAL BIG	840101	153	LED LEON	13/A1NER/LED	185
LED EQUAL BIG	840001	153	LED LINE	84/A1	183
LED EQUAL MINI	840702	155	LED MELBOURNE	27206	235
LED EQUAL MINI	840602	155	LED META	250001	41
LED EQUAL MINI	840701	155	LED META	250002	41
LED EQUAL MINI	840601	155	LED META ABAT-JOUR	250501	42
LED ETOILE	270001	158	LED META ABAT-JOUR	250502	42
LED ETOILE	270101	158	LED META ABAT-JOUR	250601	43
LED ETOILE	270002	158	LED META ABAT-JOUR	250602	43
LED ETOILE	270102	158	LED MONACO LED 3	27258	224
LED ETOILE	270009	159	LED MOOD	730302	47
LED ETOILE	270109	159	LED MOOD RGB	730102	47
LED ETOILE	270026	159	LED NASKA 1	27294	236
LED ETOILE	270126	159	LED NASKA 1	27295	236
LED FLEXA F	500600/LED	103	LED NASKA 2	27296	236
LED FLEXA FF	500719	105	LED NASKA 2	27297	236
LED FLEXA S	500004/LED	99	LED NOTA C2	363324	113
LED FLEXA S MAXI	500402/LED	94	LED NOTA C2	363224	113
LED FLEXA S MAXI	500400/LED	94	LED NOTA F2	363524	115
LED FLEXA S MAXI	500401/LED	95	LED NOTA F2	363424	115
LED FLEXA S MAXI	500440/LED	95	LED NOTA W1	360124	113
LED FLEXA S MAXI	500441/LED	95	LED NOTA W1	360024	113
LED FLEXA S MINI	500804/LED	97	LED NOTA W2	360624	113
LED FLEXA TAVOLO	505202	109	LED NOTA W2	360524	113
LED FLEXA TAVOLO	505201	109	LED O'RING T	860003	49
LED FLEXA TAVOLO	505240	109	LED O'RING T	860001	49
LED FLEXA W	500204/LED	101	LED O'RING T	860002	49
LED FORMA	690102	61	LED O'RING W	860101	49
LED FORMA	690101	61	LED O'RING W	860102	49
LED GLASS	190404	166	LED OVALE - GOLD	79/AORO	189

Indice | Indice

Indice in ordine di articolo | Index according to article name

articolo article	codice code	pagina page	articolo article	codice code	pagina page
LED OVALE - SILVER	79/AARG	189	LED TRIBECA C1	140019/LED	119
LED OVALE - WHITE	79/ABIA	189	LED TRIBECA C2	141704/LED	119
LED PERTH	27204	232	LED TRIBECA C2	141719/LED	119
LED PERTH	27205	232	LED TRIBECA C4	141904/LED	119
LED PLEX 40 - GRIGIO FUME	700/S40GRFUME	83	LED TRIBECA C4	141919/LED	119
LED PLEX 40 - GRIGIO TRASP.	700/S40GRTRAS	83	LED TRIBECA S1	140804/LED	123
LED PLEX 40 - ROSSO	700/S40ROSSO	83	LED TRIBECA S1	140819/LED	123
LED PLEX 50 - GRIGIO FUME	700/S50GRFUME	83	LED TRIBECA S1 CUBE	142104/LED	125
LED PLEX 50 - GRIGIO TRASP.	700/S50GRTRAS	83	LED TRIBECA S1 CUBE	142119/LED	125
LED PLEX 50 - ROSSO	700/S50ROSSO	83	LED TRIBECA S1 LONG	142004/LED	123
LED POINT	430002/LED	193	LED TRIBECA S1 LONG	142019/LED	123
LED POINT	430004/LED	193	LED TRIBECA S1/1	141004/LED	121
LED POINT	430019/LED	193	LED TRIBECA S1/1	141019/LED	121
LED QUADRO - ARGENTO	105/AARG	189	LED TRIBECA S1/2	141204/LED	121
LED QUADRO - ORO	105/AORO	189	LED TRIBECA S1/2	141219/LED	121
LED QUEEN'S 60	640015/LED	65	LED TRIBECA W	140704/LED	127
LED QUEEN'S 90	640115/LED	65	LED TRIBECA W	140719/LED	127
LED QUINTA 2 PLEX LARGE	465302	71	LED ZEDRA	12124	227
LED QUINTA 2 PLEX LARGE	465313	71	LED ZEDRA	12126	227
LED QUINTA SPOT C - 3000K	461024	70	LED ZEDRA DOUBLE	12128	227
LED QUINTA SPOT C - 6000K	461124	70	LED ZEDRA DOUBLE	12130	227
LED QUINTA SPOT S - 3000K	460824	70	LED ZENO Q	771402	79
LED QUINTA SPOT S - 6000K	460924	70	LED ZENO R	771502	79
LED ROCK	190804	195	LINE 2 S 120 - ALLUMINIO	400721	81
LED ROCK	190819	195	LINE 2 S 120 - SILVER	400726	81
LED ROCK 25	191304	195	LSABE99/3	LSABE99/3SIL	229
LED ROCK 25	191319	195	LSACE99/1	LSACE99/1SIL	228
LED SCUDO	990/BIA/LED	187	LSACE99/2	LSACE99/2SIL	229
LED SCUDO	990/ORO/LED	187	LSACE99/3	LSACE99/3SIL	229
LED SCUDO	990/ARG/LED	187			
LED SFERA	136/S1	73	MENSOLA per fissaggio a parete - LED MOOD	735002	45
LED SPOT 1	12168	231	MORRISON	30510	225
LED SPOT 2	12169	231	MORRISON	30512	225
LED SPOT 3	12170	231	MORRISON	30514	225
LED STILNOVO - 3000K	240102	75			
LED STILNOVO - 3000K	240103	75	OFEK	410004	63
LED STILNOVO - 3000K	240104	75	OFEK REFLECTOR	415015	63
LED STILNOVO - 6000K	240002	75	OLIVIA	810002	207
LED STILNOVO - 6000K	240003	75			
LED STILNOVO - 6000K	240004	75	POINT HALO	430002	193
LED SYDNEY	27273	233	POINT HALO	430004	193
LED SYDNEY	27274	233	POINT HALO	430019	193
LED SYDNEY	27275	233	PRIMULA 1	4014/1	221
LED TABLOID 50	341017/LED	199			
LED TA-TA RC	590102/LED	203	STICK	190204	197
LED TA-TA RC SMALL	590202/LED	203	STICK	190219	197
LED TA-TA W	590002/LED	202	STICK 25	191004	197
LED TA-TA W SMALL	590302/LED	202	STICK 25	191019	197
LED THEO	110004/LED	205	THEO RECESSING KIT	115101	205
LED THEO	110019/LED	205	TRIBECA DEC CEILING ROSE	145004	125
LED TRIBECA C1	140004/LED	119	TRIBECA DEC CEILING ROSE	145019	125

Indice | Indice

Indice in ordine di codice | Index according to article code

codice code	articolo article	pagina page	codice code	articolo article	pagina page
020100	LED LED	39	190219	STICK	197
1004/1PM	KUBIK SOFFITTO 1	218	190404	LED GLASS	166
1004/1PP	KUBIK SOFFITTO 2	219	190419	LED GLASS	166
1004/L1M	KUBIK TAVOLO 1	219	190604	LED GLASS G	166
1004/L1P	KUBIK TAVOLO 2	219	190619	LED GLASS G	166
103/A1	LED CUBE 2P	181	190804	LED ROCK	195
105/AARG	LED QUADRO - ARGENTO	189	190819	LED ROCK	195
105/AORO	LED QUADRO - ORO	189	191004	STICK 25	197
110004/LED	LED THEO	205	191019	STICK 25	197
110019/LED	LED THEO	205	191104	LED GLASS 25	167
115101	THEO RECESSING KIT	205	191119	LED GLASS 25	167
12124	LED ZEDRA	227	191204	LED GLASS G 25	167
12126	LED ZEDRA	227	191219	LED GLASS G 25	167
12128	LED ZEDRA DOUBLE	227	191304	LED ROCK 25	195
12130	LED ZEDRA DOUBLE	227	191319	LED ROCK 25	195
12168	LED SPOT 1	231	2005NKS	2005	239
12169	LED SPOT 2	231	2005SIL	2005	239
12170	LED SPOT 3	231	2007/NKS	2007	240
1229/1NIK	CAMELIA 1	217	208/P1ALL	2008	209
1229/1ORO	CAMELIA 1	217	208/P1BIA	2008	209
1229/2NIK	CAMELIA 2	217	209/P1ALL	2009	211
1229/2ORO	CAMELIA 2	217	209/P1BIA	2009	211
13/A1BIA/LED	LED LEON	185	210017/LED	LED DADO W 60	143
13/A1NER/LED	LED LEON	185	210217/LED	LED DADO MINI C	145
136/S1	LED SFERA	73	210317/LED	LED DADO MINI W	145
140004/LED	LED TRIBECA C1	119	210417/LED	LED DADO MINI W DOUBLE	143
140019/LED	LED TRIBECA C1	119	2276/A-1/LED	LED CORALLO APPLIQUE	88
140704/LED	LED TRIBECA W	127	2276/L-1/LED	LED CORALLO TAVOLO	91
140719/LED	LED TRIBECA W	127	2276/LED	LED CORALLO PIANTANA	89
140804/LED	LED TRIBECA S1	123	2276/S-1/LED	LED CORALLO SOSPENSIONE	90
140819/LED	LED TRIBECA S1	123	240002	LED STILNOVO - 6000K	75
141004/LED	LED TRIBECA S1/1	121	240003	LED STILNOVO - 6000K	75
141019/LED	LED TRIBECA S1/1	121	240004	LED STILNOVO - 6000K	75
1410BLASIL	1410	238	240102	LED STILNOVO - 3000K	75
141204/LED	LED TRIBECA S1/2	121	240103	LED STILNOVO - 3000K	75
141219/LED	LED TRIBECA S1/2	121	240104	LED STILNOVO - 3000K	75
141704/LED	LED TRIBECA C2	119	250001	LED META	41
141719/LED	LED TRIBECA C2	119	250002	LED META	41
141904/LED	LED TRIBECA C4	119	250501	LED META ABAT-JOUR	42
141919/LED	LED TRIBECA C4	119	250502	LED META ABAT-JOUR	42
142004/LED	LED TRIBECA S1 LONG	123	250601	LED META ABAT-JOUR	43
142019/LED	LED TRIBECA S1 LONG	123	250602	LED META ABAT-JOUR	43
142104/LED	LED TRIBECA S1 CUBE	125	270001	LED ETOILE	158
142119/LED	LED TRIBECA S1 CUBE	125	270002	LED ETOILE	158
145004	TRIBECA DEC CEILING ROSE	125	270009	LED ETOILE	159
145019	TRIBECA DEC CEILING ROSE	125	270026	LED ETOILE	159
150004	BABY	137	270100	LED L'ARCOBALENO F	173
155000	BABY BULB	137	270101	LED ETOILE	158
155100	BABY ELECTRIC BOX	137	270102	LED ETOILE	158
190204	STICK	197	270109	LED ETOILE	159

Indice | Indice

Indice in ordine di codice | Index according to article code

codice code	articolo article	pagina page	codice code	articolo article	pagina page
270126	LED ETOILE	159	3350/P2ALL	2010	213
270200	LED L'ARCOBALENO W	173	3350/P2BIA	2010	213
27204	LED PERTH	232	341017/LED	LED TABLOID 50	199
27205	LED PERTH	232	360024	LED NOTA W1	113
27206	LED MELBOURNE	235	360124	LED NOTA W1	113
27258	LED MONACO LED 3	224	360524	LED NOTA W2	113
27270	LED BRERA	227	360624	LED NOTA W2	113
27272	LED GRAZ	237	363224	LED NOTA C2	113
27273	LED SYDNEY	233	363324	LED NOTA C2	113
27274	LED SYDNEY	233	363424	LED NOTA F2	115
27275	LED SYDNEY	233	363524	LED NOTA F2	115
27294	LED NASKA 1	236			
27295	LED NASKA 1	236	400721	LINE 2 S 120 - ALLUMINIO	81
27296	LED NASKA 2	236	400726	LINE 2 S 120 - SILVER	81
27297	LED NASKA 2	236	4010/1	GIACINTO 3 - ARG	163
27298	LED BETTY	31	4010/30	GIACINTO 3 - WH	162
27299	LED BETTY	31	4010/40	GIACINTO 2 - WH	162
27300	LED BETTY	31	4010/50	GIACINTO 1 - WH	162
27320	LED AUSTRALIA	234	4011/1	GIACINTO 2 - ARG	163
27321	LED AUSTRALIA	234	4012/2	GIACINTO 1 - ARG	163
2742D/RUG	2742D	241	4014/1	PRIMULA 1	221
			410004	OFEK	63
30510	MORRISON	225	415015	OFEK REFLECTOR	63
30512	MORRISON	225	430002	POINT HALO	193
30514	MORRISON	225	430002/LED	LED POINT	193
30835	LED DISKO	35	430004	POINT HALO	193
30836	LED DISKO PLUS	35	430004/LED	LED POINT	193
30837	LED DISKO MOBILE BATTERY	35	430019	POINT HALO	193
310100	FAHB	37	430019/LED	LED POINT	193
32171/LED	LED CONCA	177	440115/LED	LED EG00 C	149
32172/LED	LED CONCA	177	440215/LED	LED EG00 W	149
32173/LED	LED CONCA	177	440315/LED	LED EG00 OUTDOOR IP44	149
32181/LED	LED ARCO	176	444056.0101	HALO GLOBO 70W	82-222
32182/LED	LED ARCO	176	460824	LED QUINTA SPOT S - 3000K	70
32183/LED	LED ARCO	176	460924	LED QUINTA SPOT S - 6000K	70
32200	EGO 15	223	461024	LED QUINTA SPOT C - 3000K	70
32201	EGO 15	223	461124	LED QUINTA SPOT C - 6000K	70
32202	EGO 15	223	465302	LED QUINTA 2 PLEX LARGE	71
32204	EGO 15	223	465313	LED QUINTA 2 PLEX LARGE	71
32210	EGO 25	223			
32211	EGO 25	223	500004/LED	LED FLEXA S	99
32212	EGO 25	223	500204/LED	LED FLEXA W	101
32214	EGO 25	223	500400/LED	LED FLEXA S MAXI	94
32351	ASTER - LED ASTER	133	500401/LED	LED FLEXA S MAXI	95
32351/LED	ASTER - LED ASTER	133	500402/LED	LED FLEXA S MAXI	94
32353	ASTER - LED ASTER	133	500440/LED	LED FLEXA S MAXI	95
32353/LED	ASTER - LED ASTER	133	500441/LED	LED FLEXA S MAXI	95
32355	ASTER - LED ASTER	133	500600/LED	LED FLEXA F	103
32355/LED	ASTER - LED ASTER	133	500719	LED FLEXA FF	105
32384	LED AXOLUTE W MINI	135	500804/LED	LED FLEXA S MINI	97
32388	LED AXOLUTE W MINI	135	505000	FLEXA ABAT-JOUR	106

Indice | Indice

Indice in ordine di codice | Index according to article code

codice code	articolo article	pagina page	codice code	articolo article	pagina page
505001	FLEXA ABAT-JOUR	106	800201	LED AURA 15 - BK	56
505002	FLEXA ABAT-JOUR	106	800202	LED AURA 15 - WH	56
505003	FLEXA ABAT-JOUR	107	800203	LED AURA 15 - RD	56
505040	FLEXA ABAT-JOUR	107	800226	LED AURA 6 - GR	56
505041	FLEXA ABAT-JOUR	107	801801	LED AURA COMP - Double Emission	59
505119	FLEXA CEILING ROSE	99-101	801802	LED AURA COMP - Double Emission	59
505201	LED FLEXA TAVOLO	109	801803	LED AURA COMP - Double Emission	59
505202	LED FLEXA TAVOLO	109	801817	LED AURA COMP - Double Emission	59
505240	LED FLEXA TAVOLO	109	802001	LED AURA COMP - Single Emission	59
510002/LED	LED BOX 60	141	802002	LED AURA COMP - Single Emission	59
510017/LED	LED BOX 60	141	802003	LED AURA COMP - Single Emission	59
510102/LED	LED BOX 90	141	802017	LED AURA COMP - Single Emission	59
510117/LED	LED BOX 90	141	805026	AURA CEILING ROSE 100W	57
510202/LED	LED BOX 120	141	805126	AURA CEILING ROSE 50W	57
510217/LED	LED BOX 120	141	805226	AURA CONTROSOFFITTO PLATE	57
555130.0101	LED GLOBO 16W	82-222	810002	OLIVIA	207
590002/LED	LED TA-TA W	202	830001	LED GOLF	169
590102/LED	LED TA-TA RC	203	830002	LED GOLF	169
590202/LED	LED TA-TA RC SMALL	203	830101	LED GOLF	169
590302/LED	LED TA-TA W SMALL	202	830102	LED GOLF	169
600340.0101	GEMINI GLOBO 21W	82-222	830201	LED GOLF RC	171
600350.0101	GEMINI GLOBO 25W	82-222	830202	LED GOLF RC	171
640015/LED	LED QUEEN'S 60	65	830301	LED GOLF RC	171
640115/LED	LED QUEEN'S 90	65	830302	LED GOLF RC	171
690101	LED FORMA	61	84/A1	LED LINE	183
690102	LED FORMA	61	840001	LED EQUAL BIG	153
700/S40GRFUME	LED PLEX 40 - GRIGIO FUME	83	840002	LED EQUAL BIG	153
700/S40GRTRAS	LED PLEX 40 - GRIGIO TRASP.	83	840101	LED EQUAL BIG	153
700/S40ROSSO	LED PLEX 40 - ROSSO	83	840102	LED EQUAL BIG	153
700/S50GRFUME	LED PLEX 50 - GRIGIO FUME	83	840601	LED EQUAL MINI	155
700/S50GRTRAS	LED PLEX 50 - GRIGIO TRASP.	83	840602	LED EQUAL MINI	155
700/S50ROSSO	LED PLEX 50 - ROSSO	83	840701	LED EQUAL MINI	155
730102	LED MOOD RGB	47	840702	LED EQUAL MINI	155
730302	LED MOOD	47	860001	LED O'RING T	49
735002	MENSOLA per fissaggio a parete - LED MOOD	45	860002	LED O'RING T	49
771402	LED ZENO Q	79	860003	LED O'RING T	49
771502	LED ZENO R	79	860101	LED O'RING W	49
79/AARG	LED OVALE - SILVER	189	860102	LED O'RING W	49
79/ABIA	LED OVALE - WHITE	189	88/A1	LED CUBE 1G	179
79/AORO	LED OVALE - GOLD	189	990/ARG/LED	LED SCUDO	187
800001	LED AURA 6 - BK	56	990/BIA/LED	LED SCUDO	187
800002	LED AURA 6 - WH	56	990/ORO/LED	LED SCUDO	187
800003	LED AURA 6 - RD	56	LSABE99/3SIL	LSABE99/3	229
800026	LED AURA 9 - GR	56	LSACE99/1SIL	LSACE99/1	228
800101	LED AURA 9 - BK	56	LSACE99/2SIL	LSACE99/2	229
800102	LED AURA 9 - WH	56	LSACE99/3SIL	LSACE99/3	229
800103	LED AURA 9 - RD	56			
800126	LED AURA 15 - GR	56			